

Rear trunnion - Mod. I

Product code: I-42-32

Datasheet creation date: 07/03/2025 15:59

Check the most updated document online [click here](#)

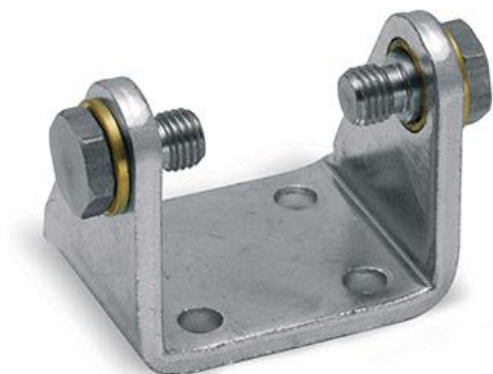

TECHNICAL DATA

Mod.	I-42-32
------	---------

Rear trunnion - Mod. I

Product code: I-42-32

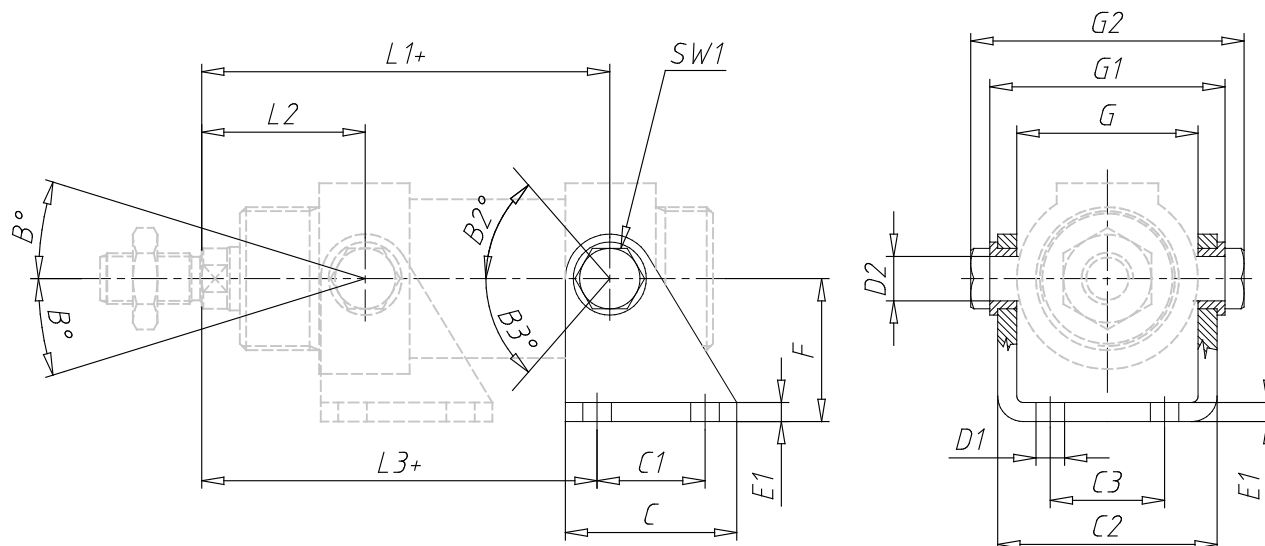

DIMENSIONS

L1 (mm)	109.5
L2 (mm)	36.5
L3 (mm)	105.5
C (mm)	40
C1 (mm)	24
C2 (mm)	46.1
C3 (mm)	20
D1 (mm)	7
D2 (mm)	10
E1 (mm)	4
F (mm)	35
SW1 (mm)	13
G (mm)	38.1
G1 (mm)	50.1
G2 (mm)	58.1