

Direct acting solenoid valve (90° connection) - Series K

Product code: K000-303-K11

Datasheet creation date: 10/03/2025 11:29

Check the most updated document online [click here](#)



TECHNICAL DATA

Series	K000
Number of ways - functions	3 = 3/2 vie - NC
Thread port	0 = manifold or single base
Orifice diameter	3 = Ø 0.6 mm - 3/2 version
Materials	K = PBT body - HNBR poppet seal (only for 3/2-way versions)
Electrical connection	1 = 90° connection with protection and led
Voltage - power consumption	1 = 6 V DC - 1 W
Fixing	= fixing screws for plastic
Options	= standard

Direct acting solenoid valve (90° connection) - Series K

Product code: K000-303-K11

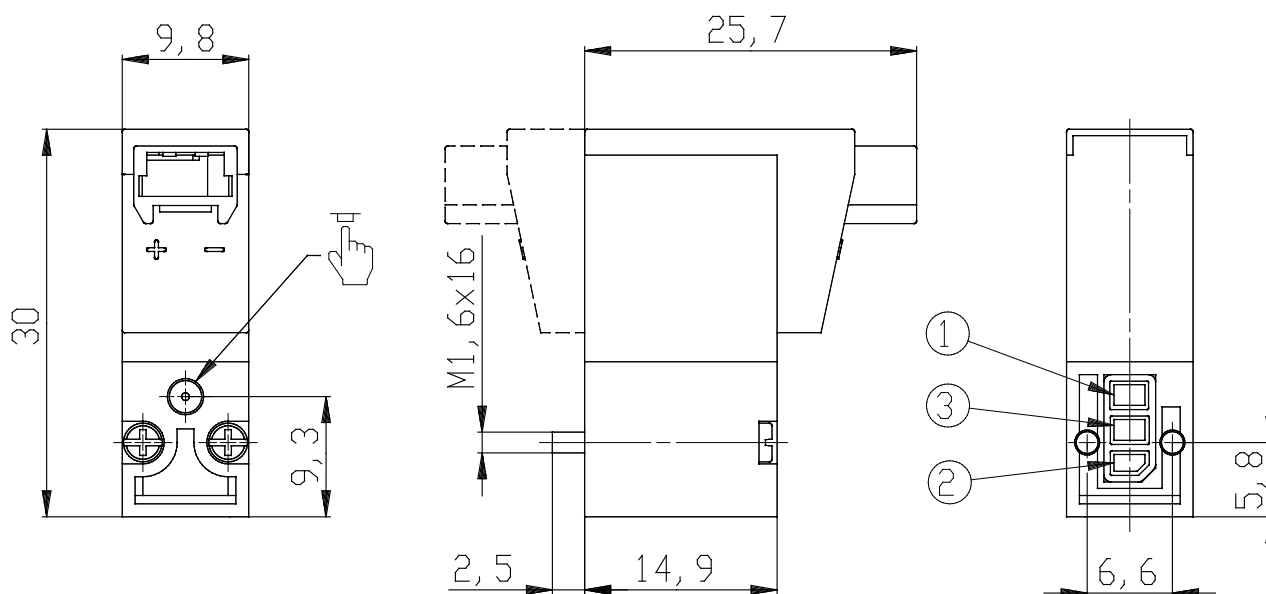

DIMENSIONS

Series	K000
Number of ways - functions	3 = 3/2 vie - NC
Thread port	0 = manifold or single base
Orifice diameter	3 = Ø 0.6 mm - 3/2 version
Materials	K = PBT body - HNBR poppet seal (only for 3/2-way versions)
Electrical connection	1 = 90° connection with protection and led
Voltage - power consumption	1 = 6 V DC - 1 W
Fixing	= fixing screws for plastic
Options	= standard