

## Direct acting solenoid valve (90° connection) - Series K

Product code: K000-403-K23M

Datasheet creation date: 10/03/2025 11:30

Check the most updated document online [click here](#)



### TECHNICAL DATA

<b>Series</b>	K000
<b>Number of ways - functions</b>	4 = 3/2 vie - NO
<b>Thread port</b>	0 = manifold or single base
<b>Orifice diameter</b>	3 = Ø 0.6 mm - 3/2 version
<b>Materials</b>	K = PBT body - HNBR poppet seal (only for 3/2-way versions)
<b>Electrical connection</b>	2 = 90° connection with protection
<b>Voltage - power consumption</b>	3 = 24 V DC - 1 W
<b>Fixing</b>	M = fixing screws for metal
<b>Options</b>	= standard

## Direct acting solenoid valve (90° connection) - Series K

Product code: K000-403-K23M

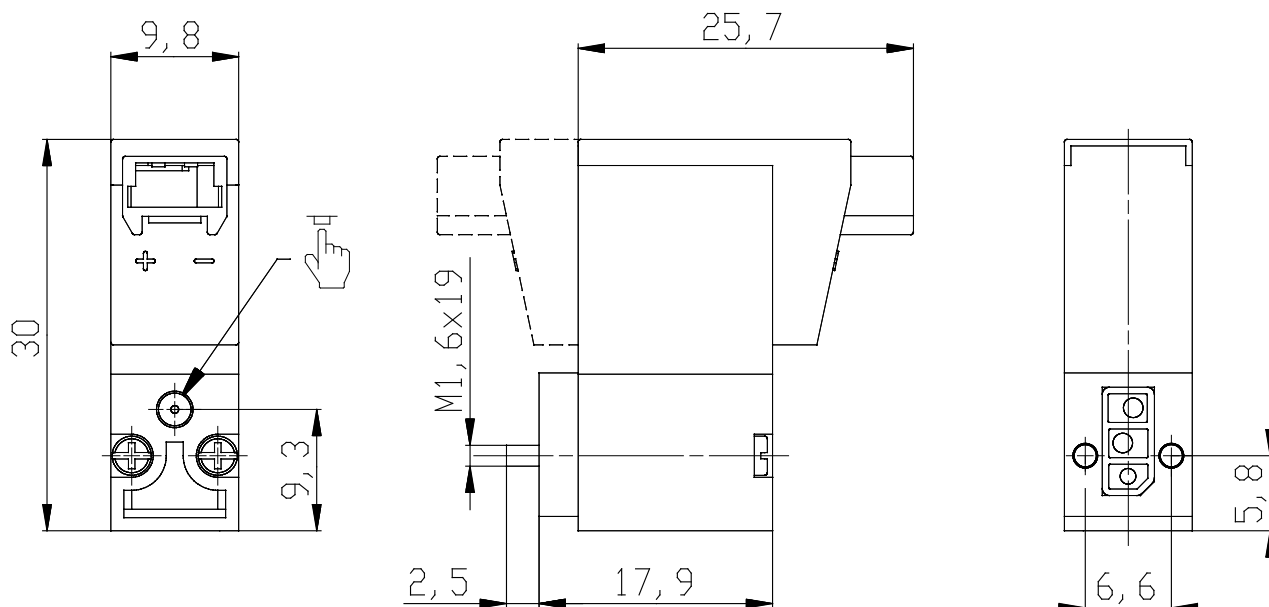

### DIMENSIONS

<b>Series</b>	K000
<b>Number of ways - functions</b>	4 = 3/2 vie - NO
<b>Thread port</b>	0 = manifold or single base
<b>Orifice diameter</b>	3 = Ø 0.6 mm - 3/2 version
<b>Materials</b>	K = PBT body - HNBR poppet seal (only for 3/2-way versions)
<b>Electrical connection</b>	2 = 90° connection with protection
<b>Voltage - power consumption</b>	3 = 24 V DC - 1 W
<b>Fixing</b>	M = fixing screws for metal
<b>Options</b>	= standard