

Direct acting solenoid valves (with cables) - Series K

Product code: K000-403-KF3M

Datasheet creation date: 10/03/2025 11:28

Check the most updated document online [click here](#)

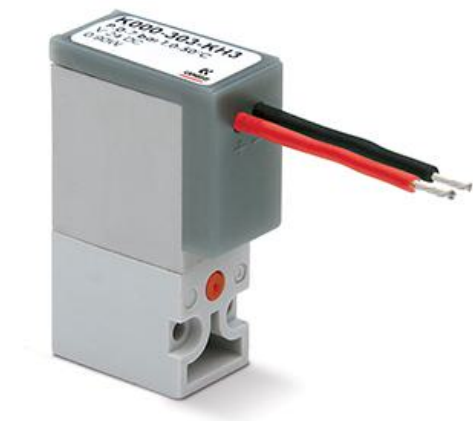

TECHNICAL DATA

Series	K000
Number of ways - functions	4 = 3/2 vie - NO
Thread port	0 = manifold or single base
Orifice diameter	3 = Ø 0.6 mm - 3/2 version
Materials	K = PBT body - HNBR poppet seal (only for 3/2-way versions)
Electrical connection	F = 300 mm flying leads with protection and led
Voltage - power consumption	3 = 24 V DC - 1 W
Fixing	M = fixing screws for metal
Options	= standard

Direct acting solenoid valves (with cables) - Series K

Product code: K000-403-KF3M

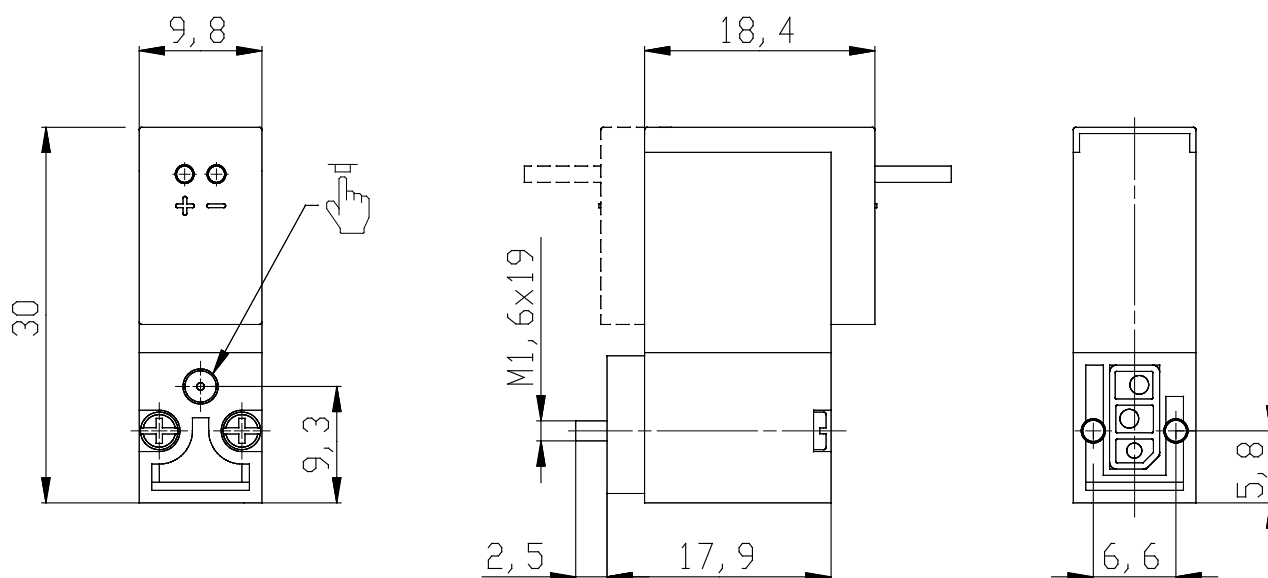

DIMENSIONS

Series	K000
Number of ways - functions	4 = 3/2 vie - NO
Thread port	0 = manifold or single base
Orifice diameter	3 = Ø 0.6 mm - 3/2 version
Materials	K = PBT body - HNBR poppet seal (only for 3/2-way versions)
Electrical connection	F = 300 mm flying leads with protection and led
Voltage - power consumption	3 = 24 V DC - 1 W
Fixing	M = fixing screws for metal
Options	= standard