

Direct acting solenoid valves - Series K8

Product code: K8000-406-K21

Datasheet creation date: 10/03/2025 11:46

Check the most updated document online [click here](#)



TECHNICAL DATA

Series	K8
Body design	0 = single valve
Body design	00 = Valve without seat
Fixing	None
Number of ways - Function	4 = 3/2 way - NO
Sealing material	0 = poppet, FKM seals
Orifice diameter	6 = Ø 0.5 mm (max pressure 4 bar)
Materials	K= brass orifice
Electric connection	2 = pins - 4 mm pitch
Voltage - Power consumption	1 = 6 V DC - 0.6W
Options	= standard

Direct acting solenoid valves - Series K8

Product code: K8000-406-K21

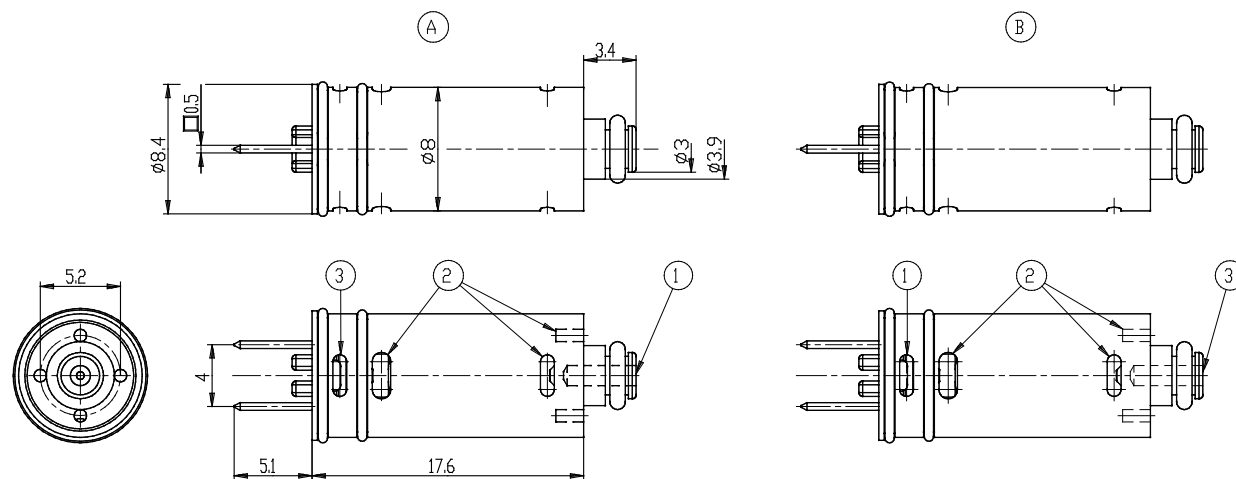

1 = ALIMENTAZIONE / INLET
 2 = UTILIZZO / OUTLET
 3 = SCARICO / EXHAUST
 A = VERSIONE 3/2 NC
 B = VERSIONE 3/2 NA

DIMENSIONS

Series	K8
Body design	0 = single valve
Body design	00 = Valve without seat
Fixing	None
Number of ways - Function	4 = 3/2 way - NO
Sealing material	0 = poppet, FKM seals
Orifice diameter	6 = Ø 0.5 mm (max pressure 4 bar)
Materials	K= brass orifice
Electric connection	2 = pins - 4 mm pitch
Voltage - Power consumption	1 = 6 V DC - 0.6W
Options	= standard