

## Direct acting solenoid valves - Series K8

Product code: K8000-705-K23

Datasheet creation date: 10/03/2025 11:47

Check the most updated document online [click here](#)



### TECHNICAL DATA

<b>Series</b>	K8
<b>Body design</b>	0 = single valve
<b>Body design</b>	00 = Valve without seat
<b>Fixing</b>	None
<b>Number of ways - Function</b>	7 = 3/2 way - UNI
<b>Sealing material</b>	0 = poppet, FKM seals
<b>Orifice diameter</b>	5 = Ø 0.7 mm
<b>Materials</b>	K= brass orifice
<b>Electric connection</b>	2 = pins - 4 mm pitch
<b>Voltage - Power consumption</b>	3 = 24 V DC - 0.6 W
<b>Options</b>	= standard

## Direct acting solenoid valves - Series K8

Product code: K8000-705-K23

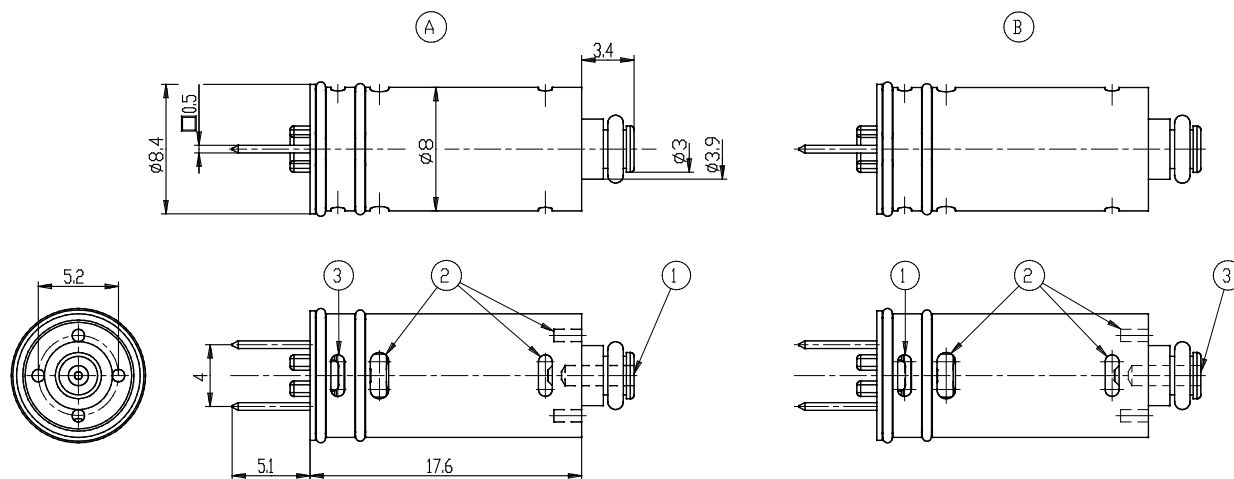

1 = ALIMENTAZIONE / INLET  
 2 = UTILIZZO / OUTLET  
 3 = SCARICO / EXHAUST  
 A = VERSIONE 3/2 NC  
 B = VERSIONE 3/2 NA

### DIMENSIONS

<b>Series</b>	K8
<b>Body design</b>	0 = single valve
<b>Body design</b>	00 = Valve without seat
<b>Fixing</b>	None
<b>Number of ways - Function</b>	7 = 3/2 way - UNI
<b>Sealing material</b>	0 = poppet, FKM seals
<b>Orifice diameter</b>	5 = Ø 0.7 mm
<b>Materials</b>	K= brass orifice
<b>Electric connection</b>	2 = pins - 4 mm pitch
<b>Voltage - Power consumption</b>	3 = 24 V DC - 0.6 W
<b>Options</b>	= standard