

Solenoid valve with threaded connections - Series K8B

Product code: K8BC3403-D431N-N001BC002

Datasheet creation date: 10/03/2025 11:45

Check the most updated document online [click here](#)



TECHNICAL DATA

Series	K8B
Body design	C3 = threaded body
Number of ways - Function	4 = 3/2-way NC
Pneumatic Connections	03 = M7
Nominal diameter	D4 = Ø 3.6mm
Seals Materials	3 = FKM
Body Materials	1 = aluminium
Manual Override	N = not foreseen
Fixing Accessories	N = not foreseen
Option	00 = no option
Electrical Connection	1B = JST connector, pitch 4mm
Voltage - Power Consumption	C002 = 12V DC (0.6 W)
Option	= standard

Solenoid valve with threaded connections - Series K8B

Product code: K8BC3403-D431N-N001BC002

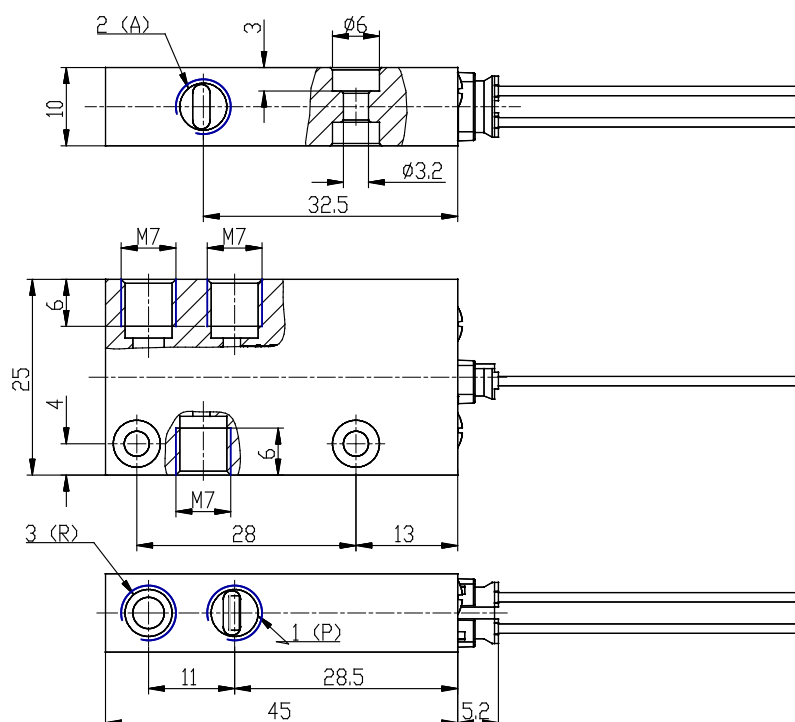

DIMENSIONS

Series	K8B
Body design	C3 = threaded body
Number of ways - Function	4 = 3/2-way NC
Pneumatic Connections	03 = M7
Nominal diameter	D4 = Ø 3.6mm
Seals Materials	3 = FKM
Body Materials	1 = aluminium
Manual Override	N = not foreseen
Fixing Accessories	N = not foreseen
Option	00 = no option
Electrical Connection	1B = JST connector, pitch 4mm
Voltage - Power Consumption	C002 = 12V DC (0.6 W)
Option	= standard