

## Solenoid valve with threaded connections - Series K8B

Product code: K8BC3403-D431N-N001BC003

Datasheet creation date: 10/03/2025 11:45

Check the most updated document online [click here](#)



### TECHNICAL DATA

<b>Series</b>	K8B
<b>Body design</b>	C3 = threaded body
<b>Number of ways - Function</b>	4 = 3/2-way NC
<b>Pneumatic Connections</b>	03 = M7
<b>Nominal diameter</b>	D4 = Ø 3.6mm
<b>Seals Materials</b>	3 = FKM
<b>Body Materials</b>	1 = aluminium
<b>Manual Override</b>	N = not foreseen
<b>Fixing Accessories</b>	N = not foreseen
<b>Option</b>	00 = no option
<b>Electrical Connection</b>	1B = JST connector, pitch 4mm
<b>Voltage - Power Consumption</b>	C003 = 24V DC (0.6 W)
<b>Option</b>	= standard

## Solenoid valve with threaded connections - Series K8B

Product code: K8BC3403-D431N-N001BC003

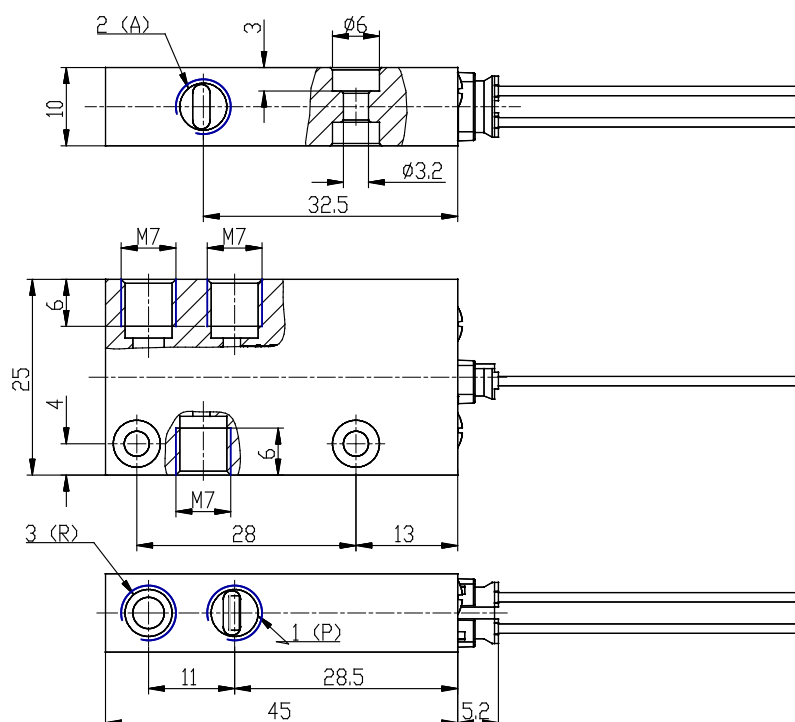

### DIMENSIONS

<b>Series</b>	K8B
<b>Body design</b>	C3 = threaded body
<b>Number of ways - Function</b>	4 = 3/2-way NC
<b>Pneumatic Connections</b>	03 = M7
<b>Nominal diameter</b>	D4 = Ø 3.6mm
<b>Seals Materials</b>	3 = FKM
<b>Body Materials</b>	1 = aluminium
<b>Manual Override</b>	N = not foreseen
<b>Fixing Accessories</b>	N = not foreseen
<b>Option</b>	00 = no option
<b>Electrical Connection</b>	1B = JST connector, pitch 4mm
<b>Voltage - Power Consumption</b>	C003 = 24V DC (0.6 W)
<b>Option</b>	= standard