

Directly operated mini-solenoid membrane valves cartridge vers. - Series K8DV

Product code: K8DVC00-505-G23

Datasheet creation date: 10/03/2025 11:47

Check the most updated document online [click here](#)



TECHNICAL DATA

Series	K8DV
Body design	C= Cartridge vers.
Number of positions	00 = Valve without seat
Number of ways - Function	5= 2 vie N.C.
Materials and Construction	0 = FKM
Nominal diameter	5= Ø 0.7mm
Materials	G= PEEK body
Type of connection	2 = 4mm pitch pin interface
Solenoid voltage	3 = 24V DC (0,6 W)
Option	= standard

Directly operated mini-solenoid membrane valves cartridge vers. - Series K8DV

Product code: K8DVC00-505-G23

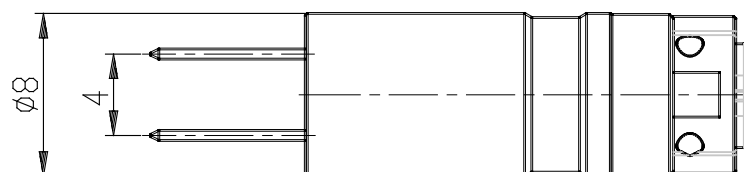
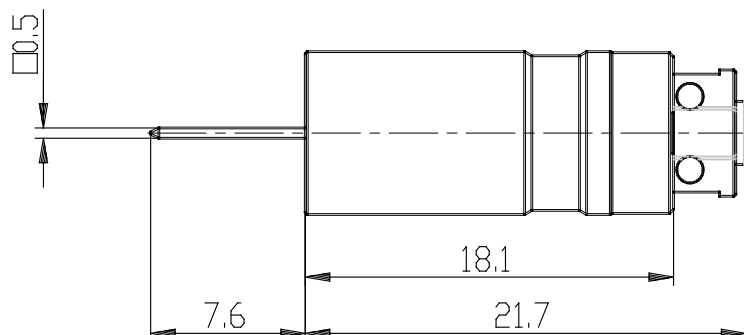
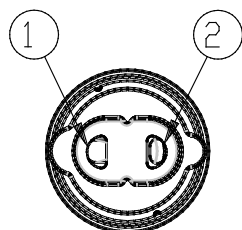

DIMENSIONS

Series	K8DV
Body design	C= Cartridge vers.
Number of positions	00 = Valve without seat
Number of ways - Function	5= 2 vie N.C.
Materials and Construction	0 = FKM
Nominal diameter	5= Ø 0.7mm
Materials	G= PEEK body
Type of connection	2 = 4mm pitch pin interface
Solenoid voltage	3 = 24V DC (0,6 W)
Option	= standard