

Electronic proportional micro regulator - Series K8P

Product code: K8P-0-D522-5F

Datasheet creation date: 10/03/2025 10:40

Check the most updated document online [click here](#)



TECHNICAL DATA

Series	K8P
Body design	0 = Stand alone
Working pressure (mm)	D = 0-10 bar
Valve functions (mm)	5= 2 ways NC
COMMAND	2 = 0-10 V DC
Output signal (mm)	2= 0-10 V
Cable length (mm)	5F = straight cable, 5 m

Electronic proportional micro regulator - Series K8P

Product code: K8P-0-D522-5F

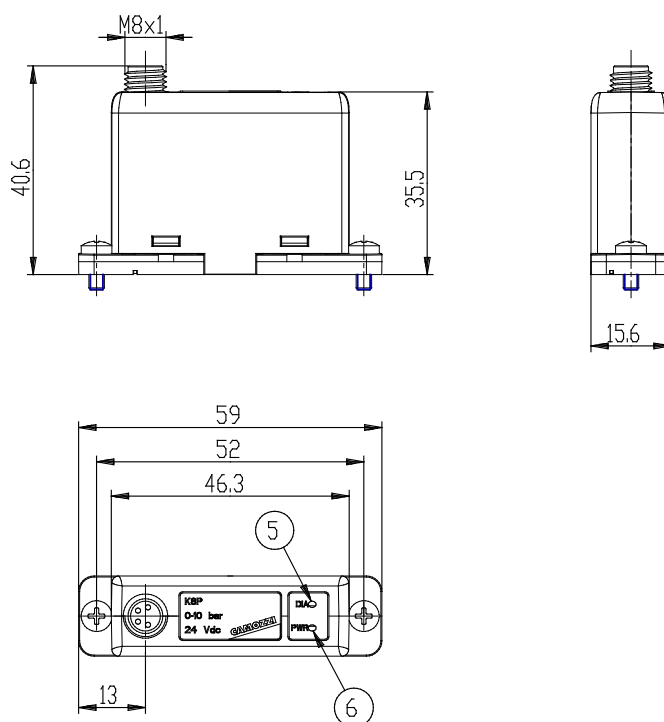

DIMENSIONS

Series	K8P
Body design	0 = Stand alone
Working pressure (mm)	D = 0-10 bar
Valve functions (mm)	5= 2 ways NC
COMMAND	2 = 0-10 V DC
Output signal (mm)	2= 0-10 V
Cable length (mm)	5F = straight cable, 5 m