

## Direct acting solenoid valves - Series K8

Product code: K8X1A-303-K33

Datasheet creation date: 10/03/2025 11:44

Check the most updated document online [click here](#)



### TECHNICAL DATA

<b>Series</b>	K8
<b>Body design</b>	X = cartridge valve with PBT body
<b>Body design</b>	1A = PBT body valve with barb fitting for Ø4/2 mm tube
<b>Fixing</b>	Vertical
<b>Number of ways - Function</b>	3 = 3/2 way - NC
<b>Sealing material</b>	0 = poppet, FKM seals
<b>Orifice diameter</b>	3 = Ø 0.5 mm (max pressure 7 bar)
<b>Materials</b>	K= brass orifice
<b>Electric connection</b>	3 = JST connector with 300 mm cables
<b>Voltage - Power consumption</b>	3 = 24 V DC - 0.6 W
<b>Options</b>	= standard

## Direct acting solenoid valves - Series K8

Product code: K8X1A-303-K33

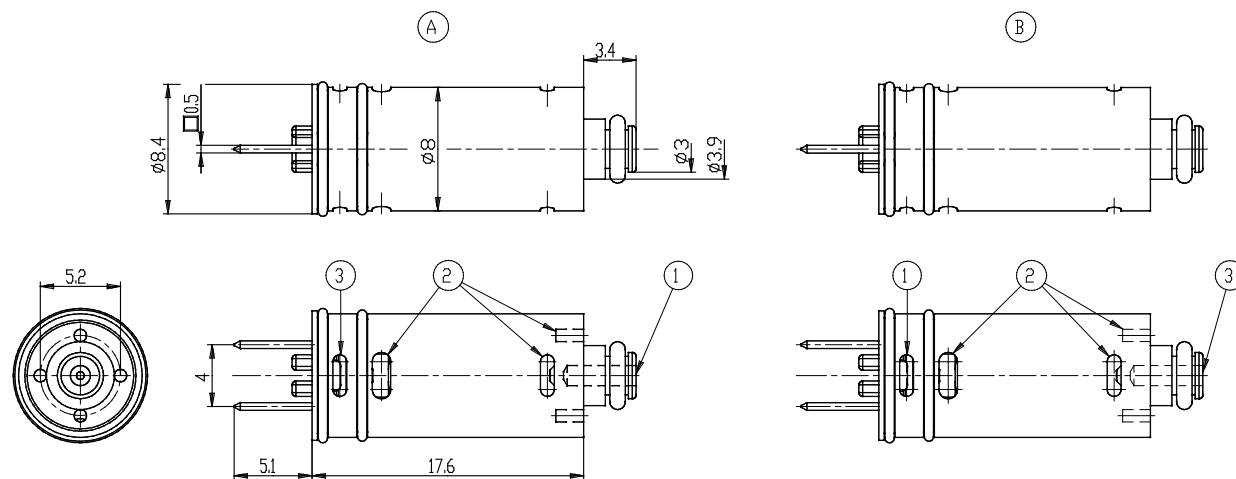

1 = ALIMENTAZIONE / INLET  
 2 = UTILIZZO / OUTLET  
 3 = SCARICO / EXHAUST  
 A = VERSIONE 3/2 NC  
 B = VERSIONE 3/2 NA

### DIMENSIONS

<b>Series</b>	K8
<b>Body design</b>	X = cartridge valve with PBT body
<b>Body design</b>	1A = PBT body valve with barb fitting for $\varnothing 4/2$ mm tube
<b>Fixing</b>	Vertical
<b>Number of ways - Function</b>	3 = 3/2 way - NC
<b>Sealing material</b>	0 = poppet, FKM seals
<b>Orifice diameter</b>	3 = $\varnothing 0.5$ mm (max pressure 7 bar)
<b>Materials</b>	K= brass orifice
<b>Electric connection</b>	3 = JST connector with 300 mm cables
<b>Voltage - Power consumption</b>	3 = 24 V DC - 0.6 W
<b>Options</b>	= standard