

Direct acting solenoid valves - Series K8

Product code: K8X1B-306-K31

Datasheet creation date: 10/03/2025 11:44

Check the most updated document online [click here](#)



TECHNICAL DATA

Series	K8
Body design	X = cartridge valve with PBT body
Body design	1B = PBT body valve with barb fitting for Ø4/2.5 mm tube
Fixing	Vertical
Number of ways - Function	3 = 3/2 way - NC
Sealing material	0 = poppet, FKM seals
Orifice diameter	6 = Ø 0.5 mm (max pressure 4 bar)
Materials	K= brass orifice
Electric connection	3 = JST connector with 300 mm cables
Voltage - Power consumption	1 = 6 V DC - 0.6W
Options	= standard

Direct acting solenoid valves - Series K8

Product code: K8X1B-306-K31

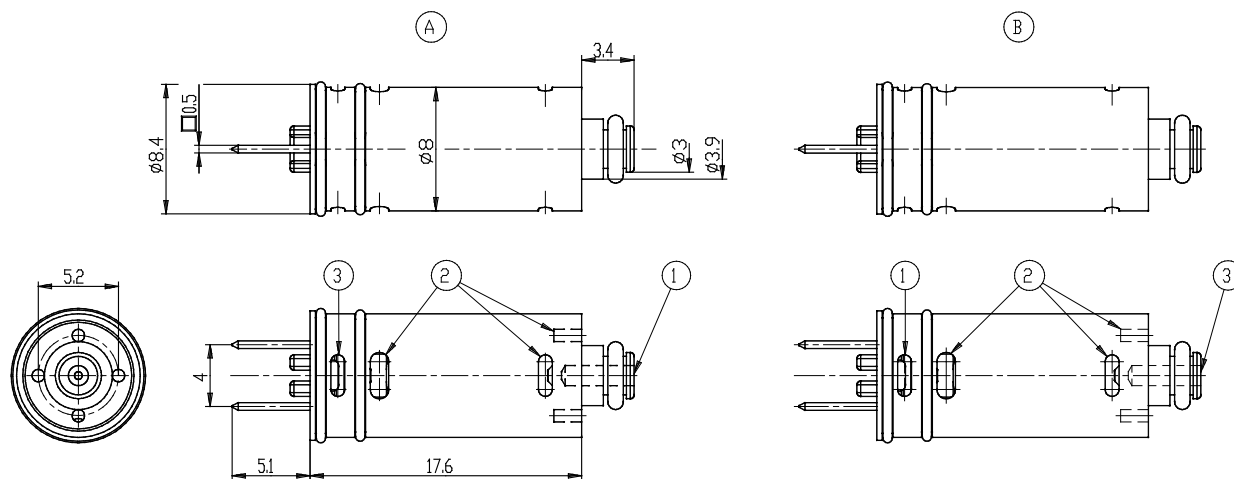

1 = ALIMENTAZIONE / INLET
 2 = UTILIZZO / OUTLET
 3 = SCARICO / EXHAUST
 A = VERSIONE 3/2 NC
 B = VERSIONE 3/2 NA

DIMENSIONS

Series	K8
Body design	X = cartridge valve with PBT body
Body design	1B = PBT body valve with barb fitting for Ø4/2.5 mm tube
Fixing	Vertical
Number of ways - Function	3 = 3/2 way - NC
Sealing material	0 = poppet, FKM seals
Orifice diameter	6 = Ø 0.5 mm (max pressure 4 bar)
Materials	K= brass orifice
Electric connection	3 = JST connector with 300 mm cables
Voltage - Power consumption	1 = 6 V DC - 0.6W
Options	= standard