

Direct acting solenoid valves - Series KL

Product code: KL040-A63A0-13M

Datasheet creation date: 10/03/2025 11:33

Check the most updated document online [click here](#)



TECHNICAL DATA

Series	KL = standard
Valvebody	0 = 3/2 body - ISO 15218
Functions	4 = 3/2 NC
Ports	0 = on sub-base or manifold
Diameter	A6 = Ø0.60 mm
Seals material	3 = FKM
Body material	A = PBT
Manual Override	0 = not requested or not foreseen
Electric connection	1 = 90 ° connector with protection and led
Voltage Power	3 = 24V DC - 1W
Fixing	M = fixing screws for metal
Option	= standard

Direct acting solenoid valves - Series KL

Product code: KL040-A63A0-13M

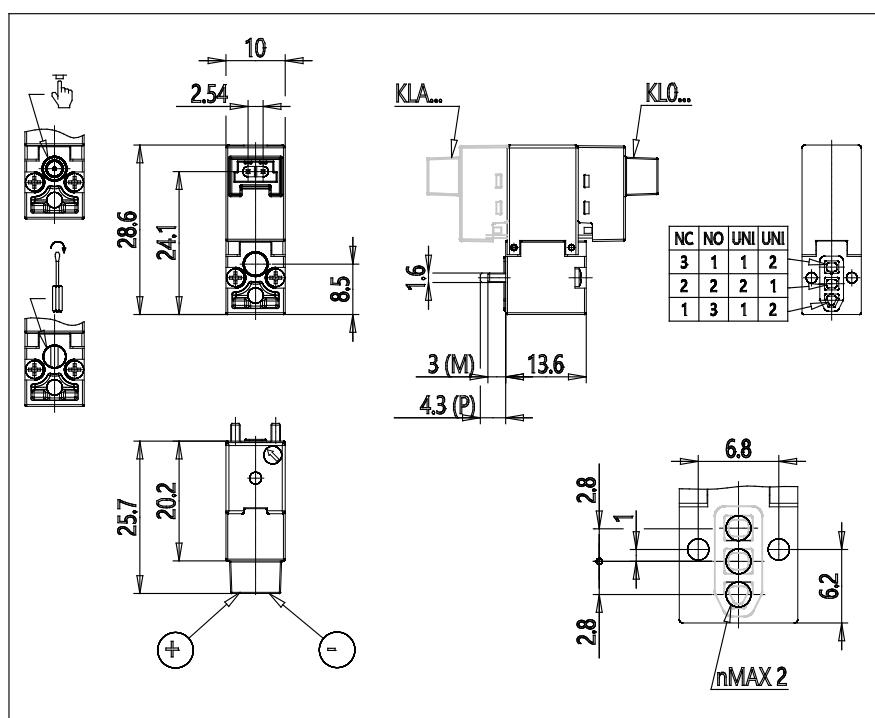

DIMENSIONS

Series	KL = standard
Valvebody	0 = 3/2 body - ISO 15218
Functions	4 = 3/2 NC
Ports	0 = on sub-base or manifold
Diameter	A6 = Ø0.60 mm
Seals material	3 = FKM
Body material	A = PBT
Manual Override	0 = not requested or not foreseen
Electric connection	1 = 90 ° connector with protection and led
Voltage Power	3 = 24V DC - 1W
Fixing	M = fixing screws for metal
Option	= standard