

## Direct acting solenoid valves - Series KL

Product code: KL040-B33A0-18M

Datasheet creation date: 10/03/2025 11:34

Check the most updated document online [click here](#)



### TECHNICAL DATA

<b>Series</b>	KL = standard
<b>Valvebody</b>	0 = 3/2 body - ISO 15218
<b>Functions</b>	4 = 3/2 NC
<b>Ports</b>	0 = on sub-base or manifold
<b>Diameter</b>	B3 = Ø1.30 mm
<b>Seals material</b>	3 = FKM
<b>Body material</b>	A = PBT
<b>Manual Override</b>	0 = not requested or not foreseen
<b>Electric connection</b>	1 = 90 ° connector with protection and led
<b>Voltage Power</b>	8 = 24V DC - 4/1W
<b>Fixing</b>	M = fixing screws for metal
<b>Option</b>	= standard

## Direct acting solenoid valves - Series KL

Product code: KL040-B33A0-18M

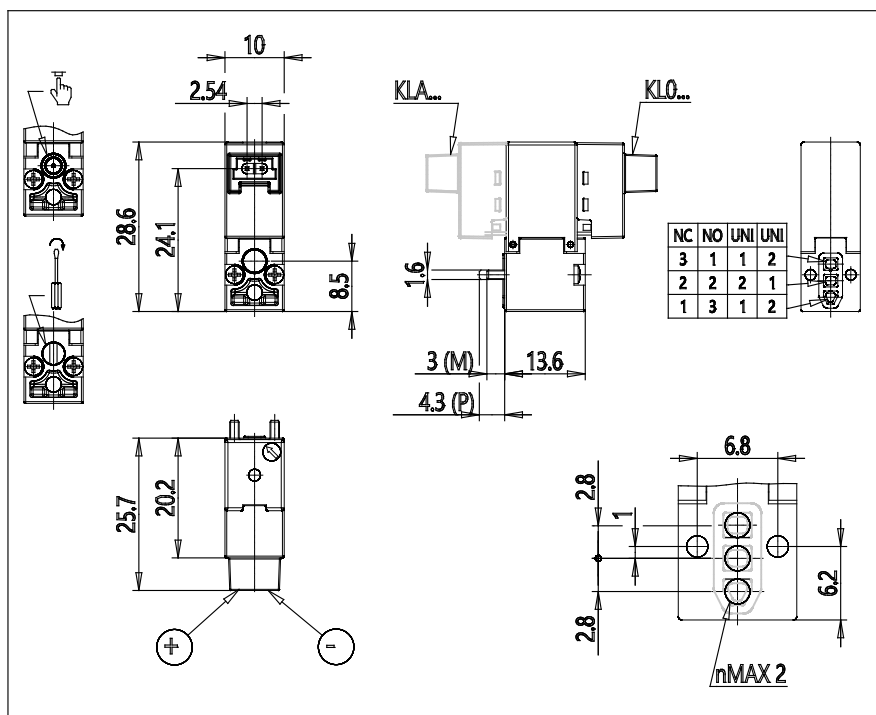

### DIMENSIONS

<b>Series</b>	KL = standard
<b>Valvebody</b>	0 = 3/2 body - ISO 15218
<b>Functions</b>	4 = 3/2 NC
<b>Ports</b>	0 = on sub-base or manifold
<b>Diameter</b>	B3 = Ø1.30 mm
<b>Seals material</b>	3 = FKM
<b>Body material</b>	A = PBT
<b>Manual Override</b>	0 = not requested or not foreseen
<b>Electric connection</b>	1 = 90 ° connector with protection and led
<b>Voltage Power</b>	8 = 24V DC - 4/1W
<b>Fixing</b>	M = fixing screws for metal
<b>Option</b>	= standard