

## Digital proportional servo valves - Series LR

Product code: LRPD2-36-2-E-00

Datasheet creation date: 10/03/2025 12:09

Check the most updated document online [click here](#)



### TECHNICAL DATA

<b>Series</b>	L = proportional servo valves
<b>Technology</b>	R = rotating spool
<b>Version</b>	P = pressure control
<b>Electronics</b>	D = digital
<b>Model</b>	2 = compact DIN-RAIL
<b>Function</b>	3 = 3/3 ways
<b>Nominal diameter</b>	6 = 6 mm
<b>Command signal (setpoint)</b>	2 = 0-10 V
<b>FEEDBACK SIGNAL</b>	E = 250 mbar (internal sensor)
<b>Cable</b>	00 = no cable

## Digital proportional servo valves - Series LR

Product code: LRPD2-36-2-E-00

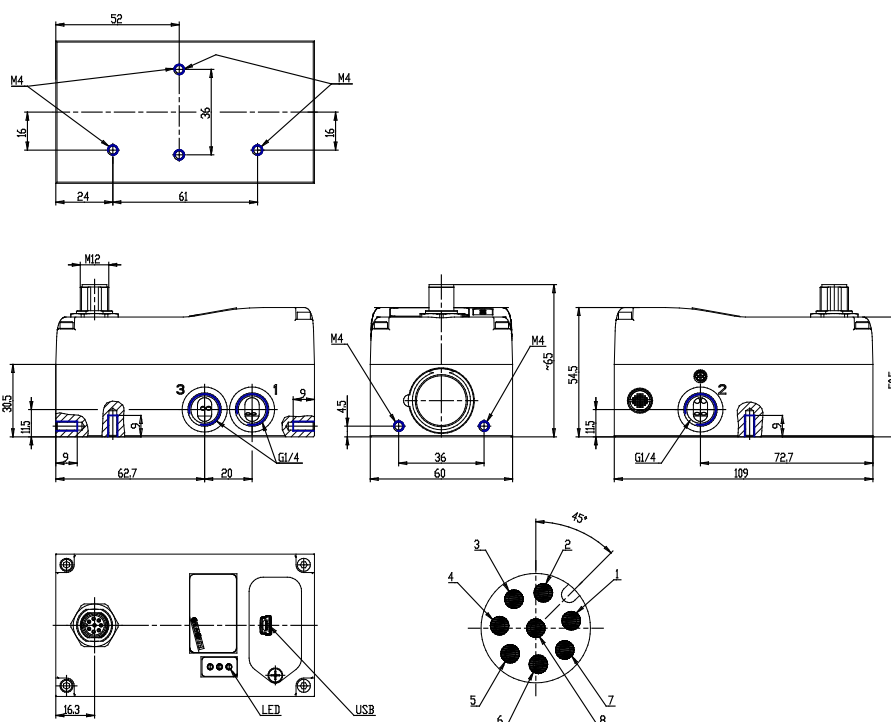

### DIMENSIONS

<b>Series</b>	L = proportional servo valves
<b>Technology</b>	R = rotating spool
<b>Version</b>	P = pressure control
<b>Electronics</b>	D = digital
<b>Model</b>	2 = compact DIN-RAIL
<b>Function</b>	3 = 3/3 ways
<b>Nominal diameter</b>	6 = 6 mm
<b>Command signal (setpoint)</b>	2 = 0-10 V
<b>FEEDBACK SIGNAL</b>	E = 250 mbar (internal sensor)
<b>Cable</b>	00 = no cable