

Digital proportional servo valves - Series LR

Product code: LRWD2-36-1-A-00

Datasheet creation date: 10/03/2025 12:08

Check the most updated document online [click here](#)



TECHNICAL DATA

Series	L = proportional servo valves
Technology	R = rotating spool
Version	W = flow control
Electronics	D = digital
Model	2 = compact DIN-RAIL
Function	3 = 3/3 ways
Nominal diameter	6 = 6 mm
Command signal (setpoint)	1 = +/- 10 V
FEEDBACK SIGNAL	A = internal encoder
Cable	00 = no cable

Digital proportional servo valves - Series LR

Product code: LRWD2-36-1-A-00

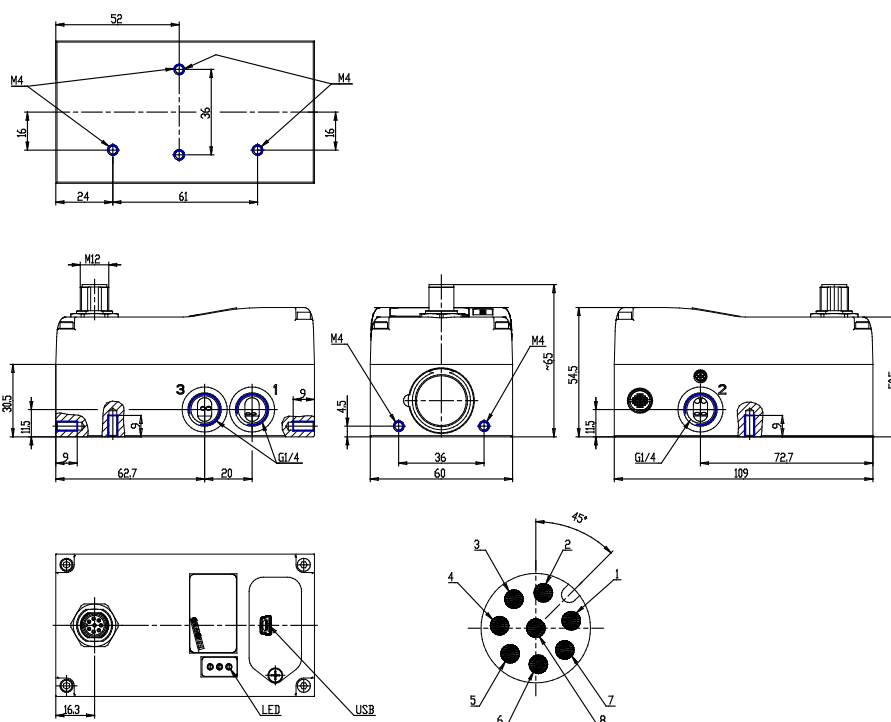

DIMENSIONS

Series	L = proportional servo valves
Technology	R = rotating spool
Version	W = flow control
Electronics	D = digital
Model	2 = compact DIN-RAIL
Function	3 = 3/3 ways
Nominal diameter	6 = 6 mm
Command signal (setpoint)	1 = +/- 10 V
FEEDBACK SIGNAL	A = internal encoder
Cable	00 = no cable