

## Pressure microregulator Series M - Series M

Product code: M004-R15

Datasheet creation date: 10/03/2025 00:43

Check the most updated document online [click here](#)



### TECHNICAL DATA

Mod.	M004-R15
R (mm)	3
U	G1/4

## Pressure microregulator Series M - Series M

Product code: M004-R15

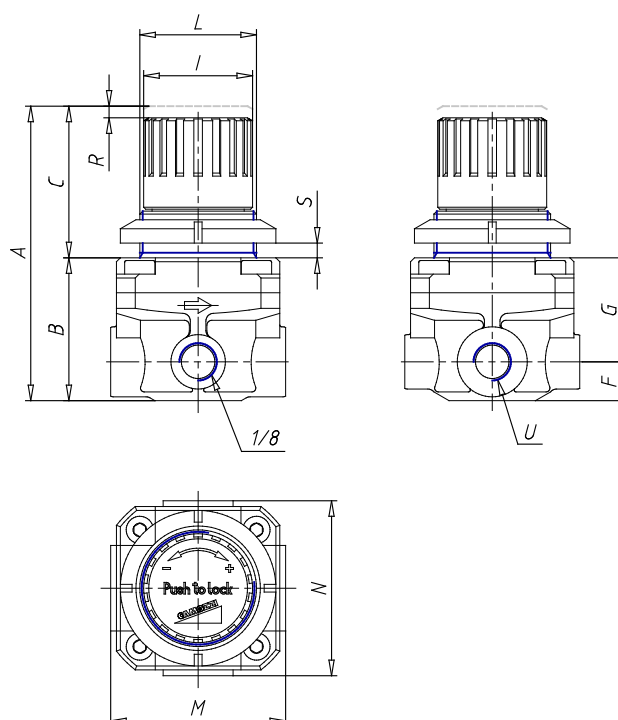

### DIMENSIONS

<b>A (mm)</b>	76
<b>B (mm)</b>	37
<b>C (mm)</b>	39
<b>F (mm)</b>	10
<b>G (mm)</b>	27
<b>I (mm)</b>	28
<b>L</b>	30x1.5
<b>M (mm)</b>	45
<b>N (mm)</b>	45