

Pressure microregulator Series M - Series M

Product code: M008-R75-VS

Datasheet creation date: 10/03/2025 00:44

Check the most updated document online [click here](#)



TECHNICAL DATA

Mod.	M008-R75-VS
R (mm)	3
U	G1/8

Pressure microregulator Series M - Series M

Product code: M008-R75-VS

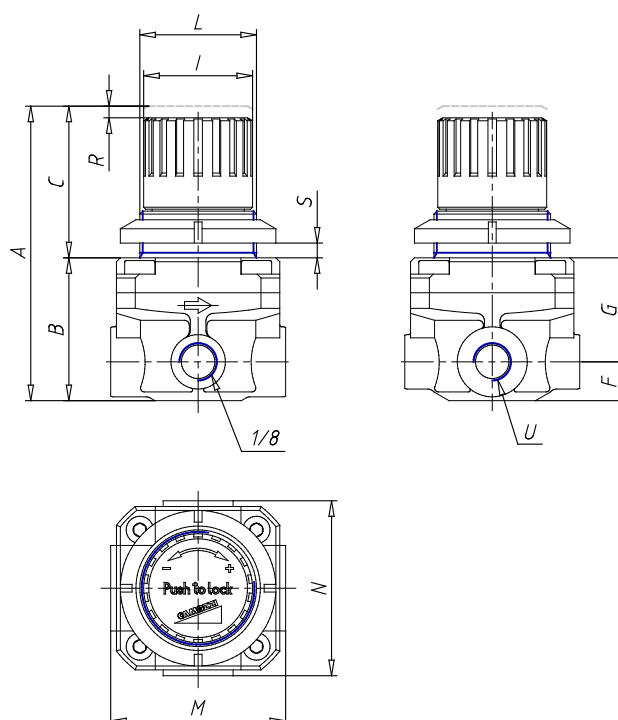

DIMENSIONS

A (mm)	76
B (mm)	37
C (mm)	39
F (mm)	10
G (mm)	27
I (mm)	28
L	30x1.5
M (mm)	45
N (mm)	45