

## Filter-regulators - Series MC

Product code: MC104-D18

Datasheet creation date: 10/03/2025 00:51

Check the most updated document online [click here](#)



### TECHNICAL DATA

Mod.	MC104-D18
U	G1/4

## Filter-regulators - Series MC

Product code: MC104-D18

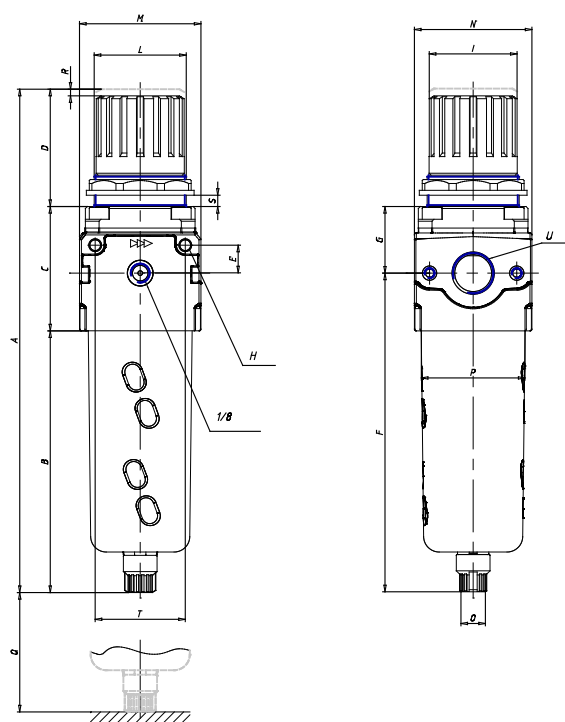

### DIMENSIONS

<b>A (mm)</b>	190.5
<b>B (mm)</b>	102
<b>C (mm)</b>	52
<b>D (mm)</b>	38
<b>E (mm)</b>	11
<b>F (mm)</b>	126.5
<b>G (mm)</b>	27.5
<b>H (mm)</b>	4.5
<b>I (mm)</b>	28
<b>L</b>	30x1.5
<b>M (mm)</b>	45
<b>N (mm)</b>	45
<b>O</b>	G1/8
<b>P (mm)</b>	37
<b>Q (mm)</b>	58
<b>R (mm)</b>	3.0
<b>S</b>	0:6
<b>T (mm)</b>	35