

Filters - Series MC

Product code: MC104-F14

Datasheet creation date: 10/03/2025 00:49

Check the most updated document online [click here](#)



TECHNICAL DATA

Mod.	MC104-F14
U	G1/4

Filters - Series MC

Product code: MC104-F14

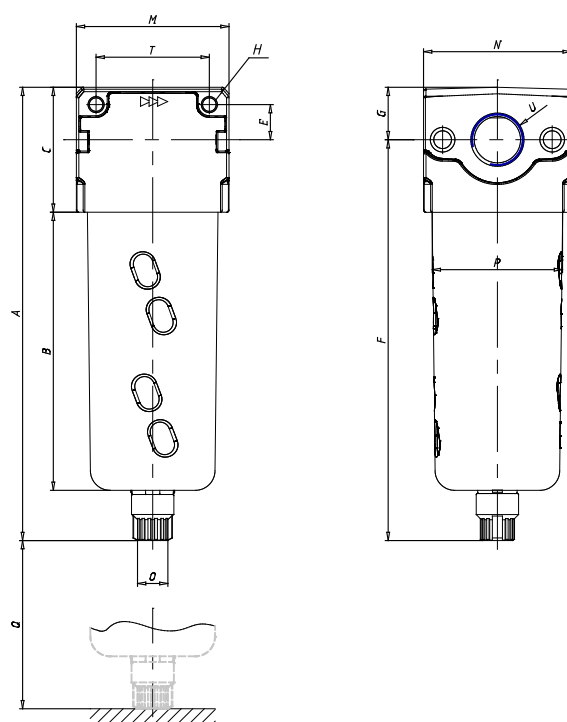

DIMENSIONS

A (mm)	143
B (mm)	102
C (mm)	41
E (mm)	11
F (mm)	126.5
G (mm)	16.5
H (mm)	4.5
M (mm)	45
N (mm)	45
O	G1/8
P (mm)	37
Q (mm)	58
T (mm)	35