

Manifold regulators - Series MC

Product code: MC104-M15

Datasheet creation date: 10/03/2025 00:52

Check the most updated document online [click here](#)



TECHNICAL DATA

Mod.	MC104-M15
------	-----------

Manifold regulators - Series MC

Product code: MC104-M15

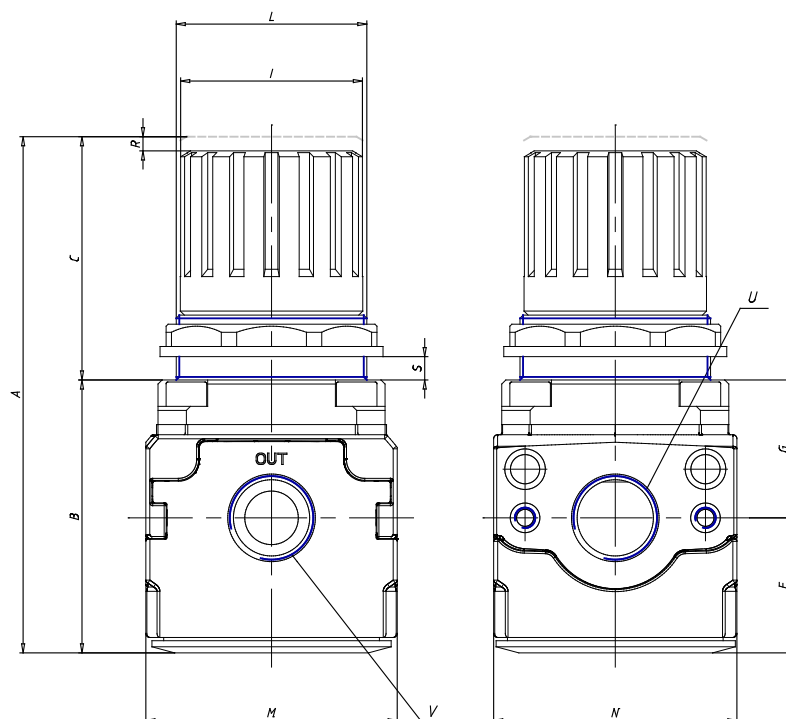

DIMENSIONS

A (mm)	94
B (mm)	55
C (mm)	39
F (mm)	28
G (mm)	28
I (mm)	28
L	30x1.5
M (mm)	45
N (mm)	45
R (mm)	3
S	0:6
U	G1/4
V	G1/8