

## Manifold regulators - Series MC

Product code: MC104-M70

Datasheet creation date: 10/03/2025 00:52

Check the most updated document online [click here](#)



### TECHNICAL DATA

Mod.	MC104-M70
------	-----------

## Manifold regulators - Series MC

Product code: MC104-M70

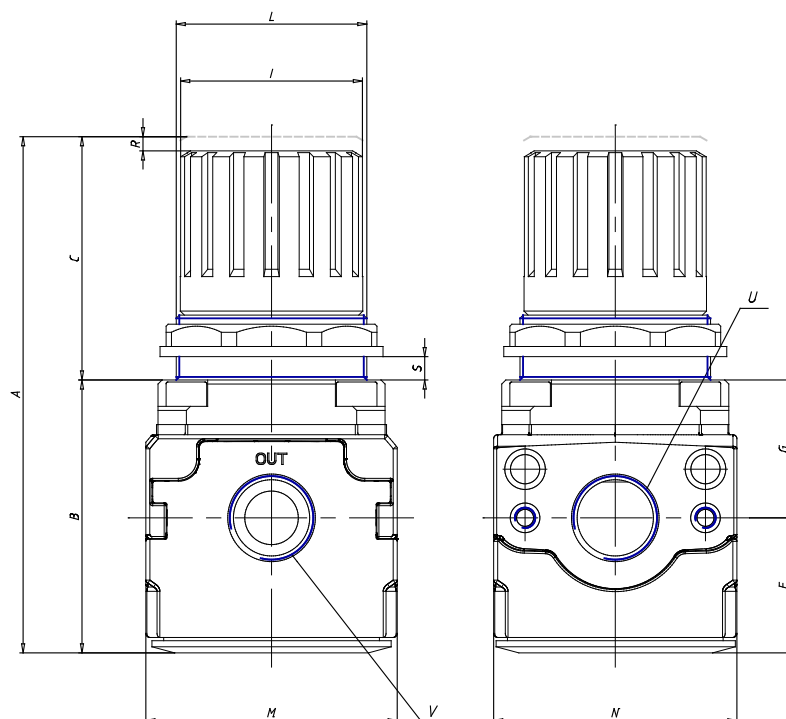

### DIMENSIONS

<b>A (mm)</b>	94
<b>B (mm)</b>	55
<b>C (mm)</b>	39
<b>F (mm)</b>	28
<b>G (mm)</b>	28
<b>I (mm)</b>	28
<b>L</b>	30x1.5
<b>M (mm)</b>	45
<b>N (mm)</b>	45
<b>R (mm)</b>	3
<b>S</b>	0:6
<b>U</b>	G1/4
<b>V</b>	G1/8