

Regulators - Series MC

Product code: MC104-R20

Datasheet creation date: 10/03/2025 00:52

Check the most updated document online [click here](#)



TECHNICAL DATA

Mod.	MC104-R20
U	G1/4

Regulators - Series MC

Product code: MC104-R20

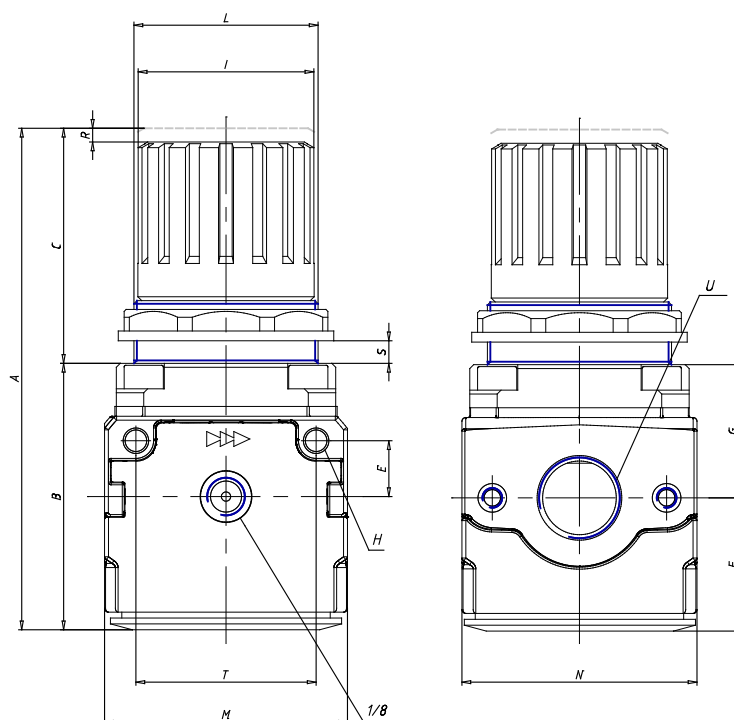

DIMENSIONS

A (mm)	94
B (mm)	56
C (mm)	38
E (mm)	11
F (mm)	28.5
G (mm)	27.5
H (mm)	4.5
I (mm)	28
L	30x1.5
M (mm)	45
N (mm)	45
R (mm)	3.0
S	0.6
T (mm)	35