

Take off block - Series MC

Product code: MC2-B-VNR

Datasheet creation date: 10/03/2025 10:43

Check the most updated document online [click here](#)



TECHNICAL DATA

Mod.	MC2-B-VNR
U	1/2

Take off block - Series MC

Product code: MC2-B-VNR

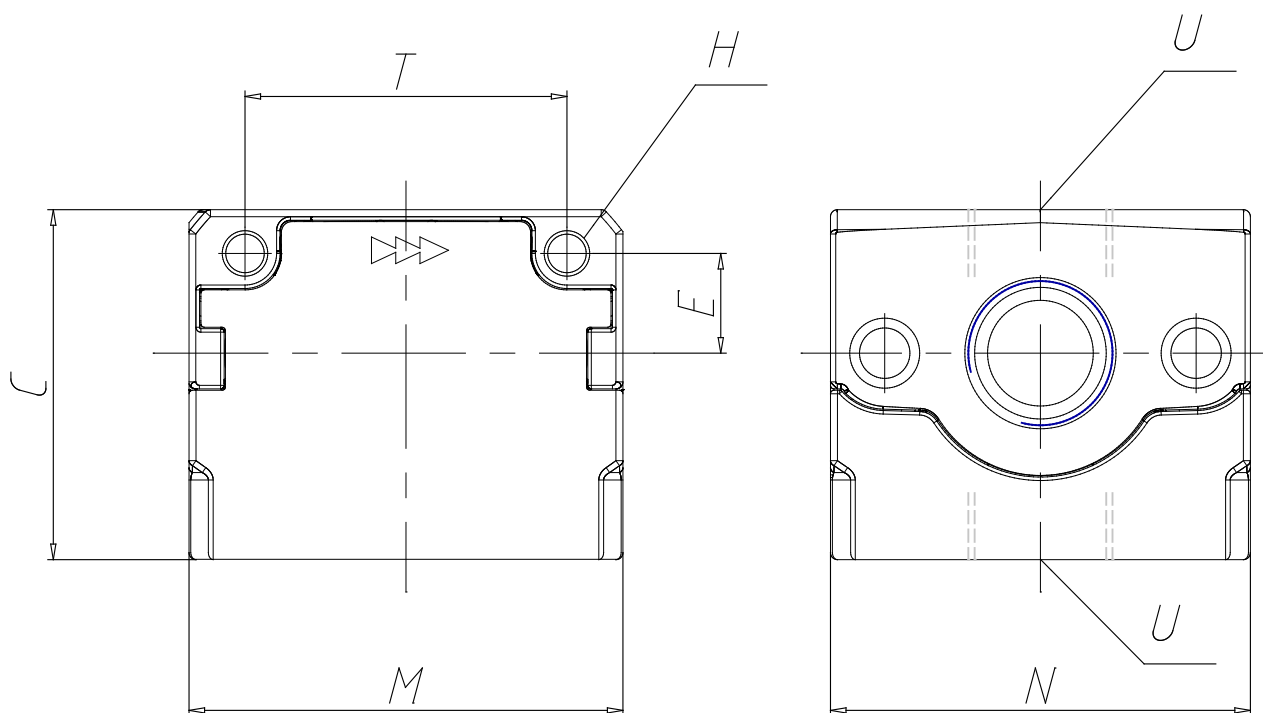

DIMENSIONS

C (mm)	50
H (mm)	5.5
E (mm)	14
M (mm)	62
N (mm)	60
T (mm)	46