

Tie-rod for assembling TMF - Series MC

Product code: MC2-TMF

Datasheet creation date: 07/03/2025 16:06

Check the most updated document online [click here](#)



TECHNICAL DATA

Mod.	MC2-TMF
------	---------

Tie-rod for assembling TMF - Series MC

Product code: MC2-TMF

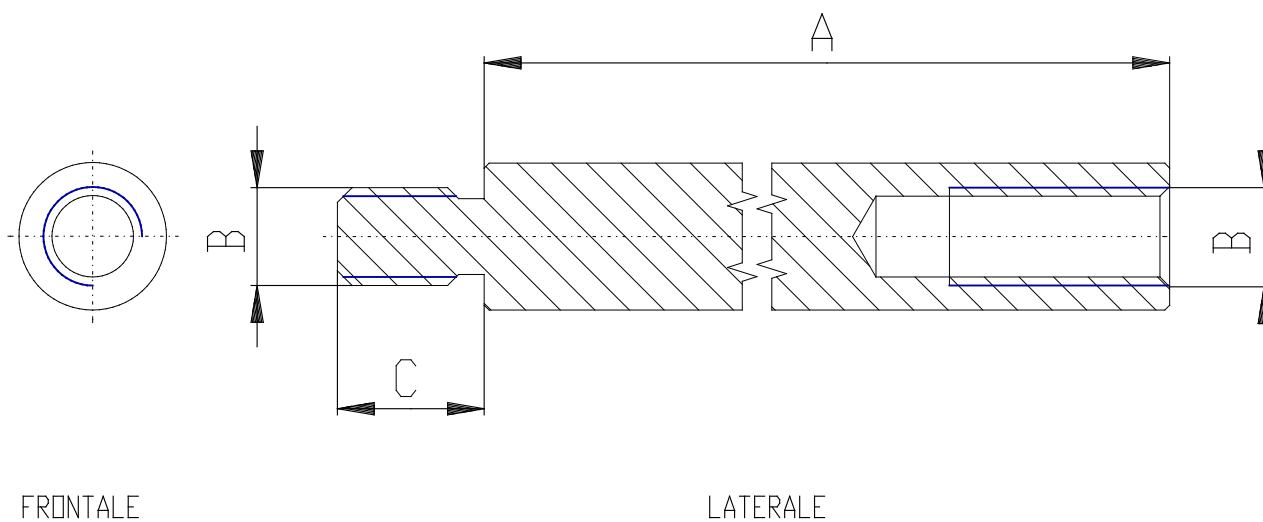

DIMENSIONS

A (mm)	62
B	M5
C (mm)	6
Size	2