

Assembly screws VMD - Series MC

Product code: MC2-VMD

Datasheet creation date: 07/03/2025 16:06

Check the most updated document online [click here](#)



TECHNICAL DATA

Mod.	MC2-VMD
------	---------

Assembly screws VMD - Series MC

Product code: MC2-VMD

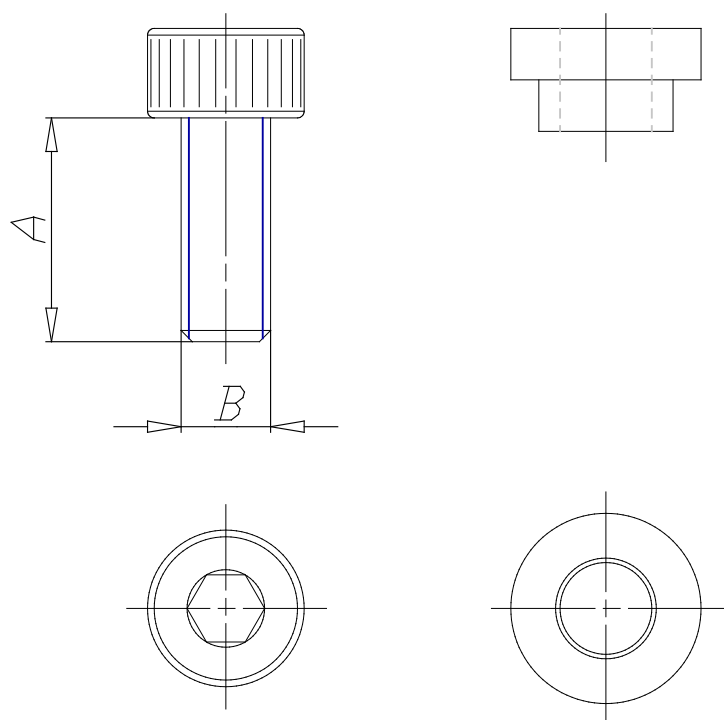

DIMENSIONS

A (mm)	12
B	M5
Size (mm)	2