

## Filter-regulators - Series MC

Product code: MC202-D13

Datasheet creation date: 10/03/2025 00:50

Check the most updated document online [click here](#)



### TECHNICAL DATA

Mod.	MC202-D13
U	G1/2

## Filter-regulators - Series MC

Product code: MC202-D13

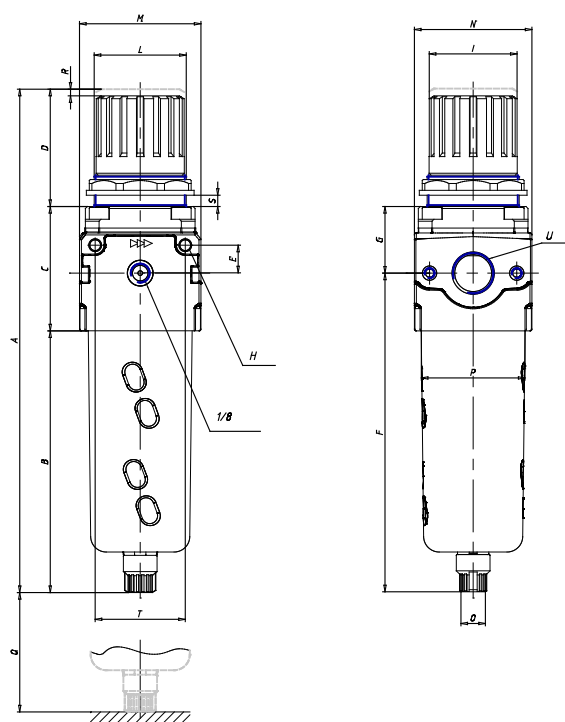

### DIMENSIONS

<b>A (mm)</b>	256.5
<b>B (mm)</b>	133
<b>C (mm)</b>	64
<b>D (mm)</b>	59
<b>E (mm)</b>	14
<b>F (mm)</b>	162.0
<b>G (mm)</b>	35.0
<b>H (mm)</b>	5.5
<b>I (mm)</b>	45
<b>L</b>	47x1.5
<b>M (mm)</b>	62
<b>N (mm)</b>	59
<b>O</b>	G1/8
<b>P (mm)</b>	53
<b>Q (mm)</b>	72
<b>R (mm)</b>	3.5
<b>S</b>	0:9
<b>T (mm)</b>	46