

## Assembly group FRL - Series MC

Product code: MC202-FRL-5-FL

Datasheet creation date: 10/03/2025 00:45

Check the most updated document online [click here](#)



### TECHNICAL DATA

Mod.	MC202-FRL-5-FL
------	----------------

## Assembly group FRL - Series MC

Product code: MC202-FRL-5-FL

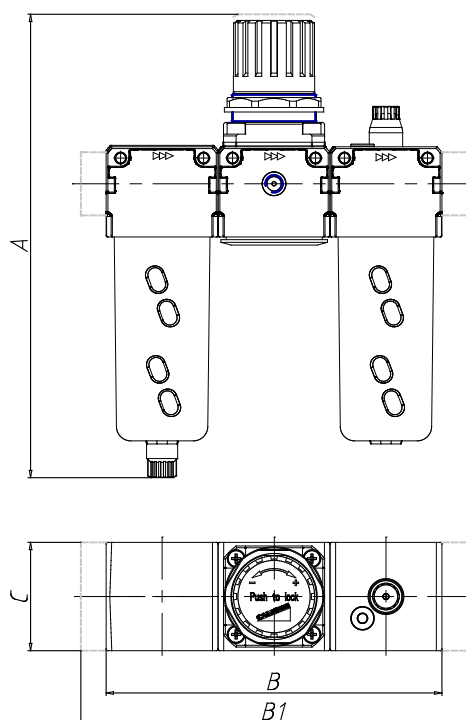

### DIMENSIONS

<b>A (mm)</b>	256.5
<b>B (mm)</b>	-
<b>B1 (mm)</b>	214
<b>C (mm)</b>	60
<b>Flow rate NI/min</b>	4900