

Regulators - Series MC

Product code: MC202-R01

Datasheet creation date: 10/03/2025 00:52

Check the most updated document online [click here](#)



TECHNICAL DATA

Mod.	MC202-R01
U	G1/2

Regulators - Series MC

Product code: MC202-R01

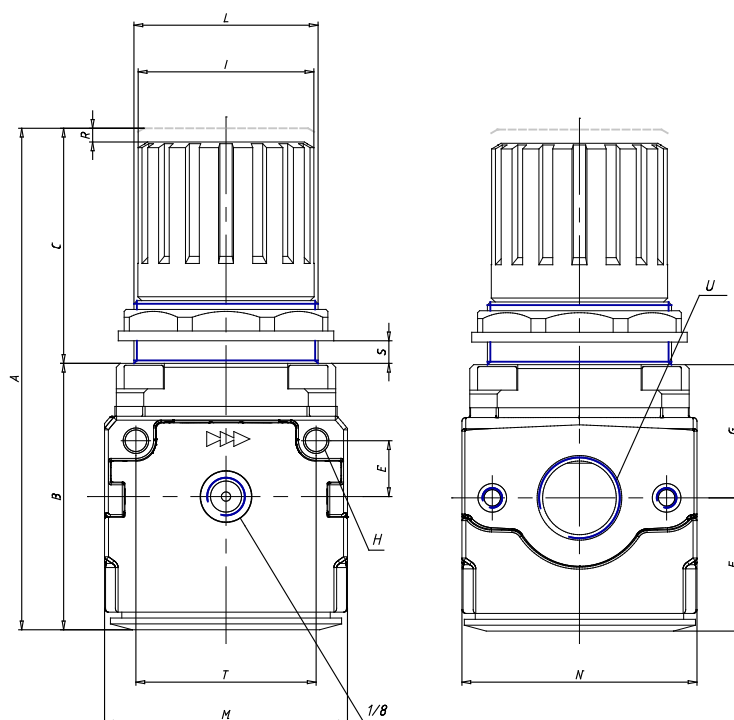

DIMENSIONS

A (mm)	127
B (mm)	67
C (mm)	60
E (mm)	14
F (mm)	34.0
G (mm)	35.0
H (mm)	5.5
I (mm)	45
L	47x1.5
M (mm)	62
N (mm)	60
R (mm)	3.5
S	0:9
T (mm)	46