

Soft Start valve - Series MC

Product code: MC238-AV

Datasheet creation date: 10/03/2025 00:48

Check the most updated document online [click here](#)



TECHNICAL DATA

Mod. (mm)	MC238-AV
U	G3/8

Soft Start valve - Series MC

Product code: MC238-AV

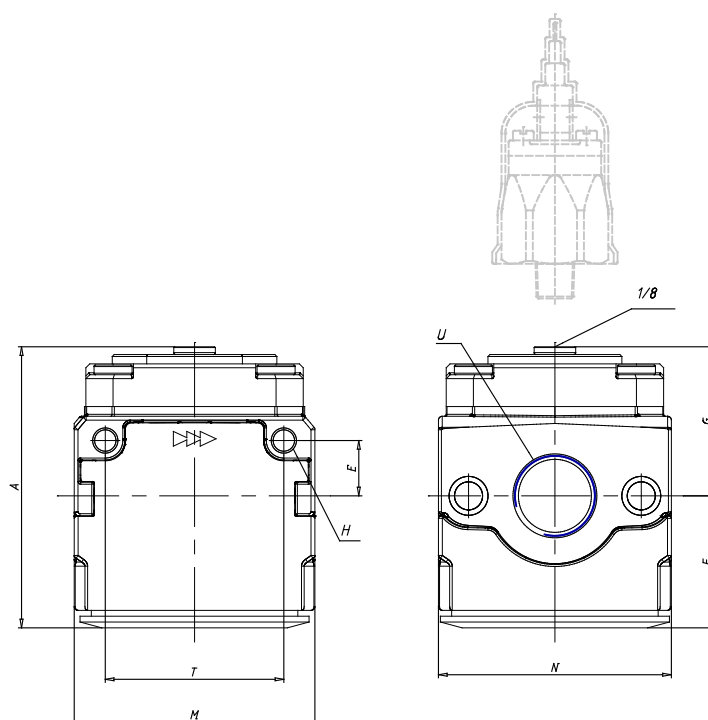

DIMENSIONS

A (mm)	72.5
E (mm)	14
F (mm)	34.0
G (mm)	38.5
H (mm)	5.5
M (mm)	62
N (mm)	60
T (mm)	46