

Filter-regulators - Series MC

Product code: MC238-D00

Datasheet creation date: 10/03/2025 00:51

Check the most updated document online [click here](#)



TECHNICAL DATA

Mod.	MC238-D00
U	G3/8

Filter-regulators - Series MC

Product code: MC238-D00

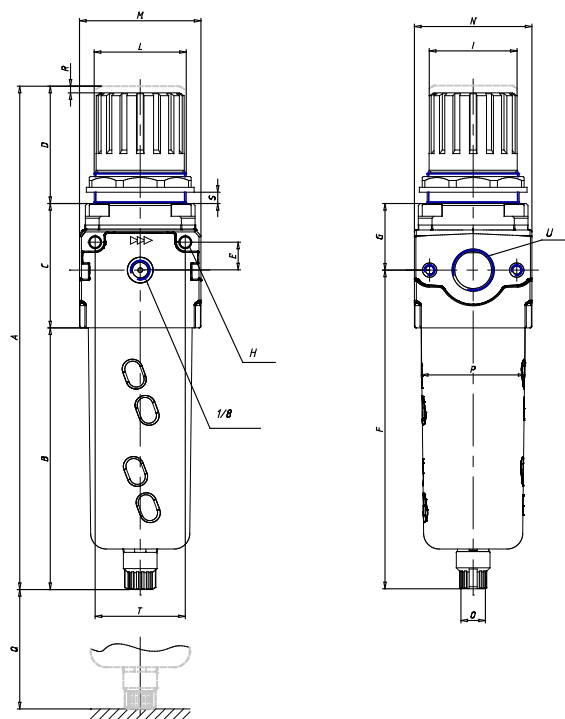

DIMENSIONS

A (mm)	256.5
B (mm)	133
C (mm)	64
D (mm)	59
E (mm)	14
F (mm)	162.0
G (mm)	35.0
H (mm)	5.5
I (mm)	45
L	47x1.5
M (mm)	62
N (mm)	59
O	G1/8
P (mm)	53
Q (mm)	72
R (mm)	3.5
S	0:9
T (mm)	46