

Filters - Series MC

Product code: MC238-F10

Datasheet creation date: 10/03/2025 00:49

Check the most updated document online [click here](#)



TECHNICAL DATA

Mod.	MC238-F10
U	G3/8

Filters - Series MC

Product code: MC238-F10

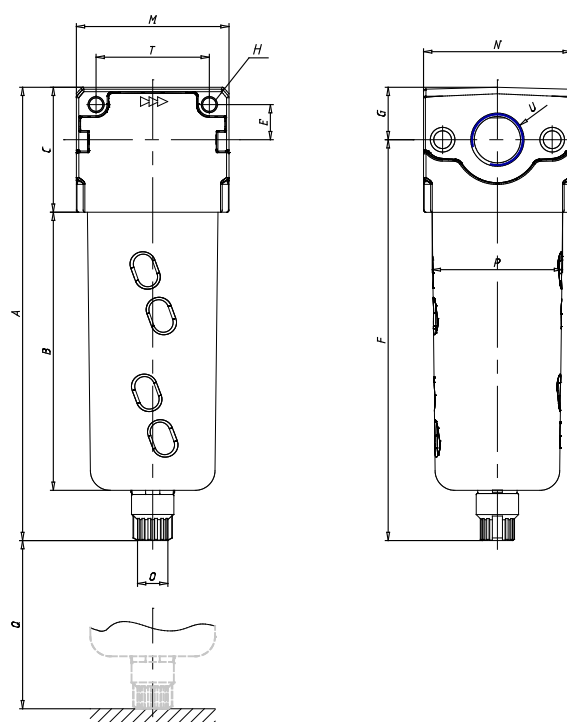

DIMENSIONS

A (mm)	184
B (mm)	133
C (mm)	51
E (mm)	14
F (mm)	126.5
G (mm)	21.0
H (mm)	5.5
M (mm)	62
N (mm)	60
O	G1/8
P (mm)	53
Q (mm)	72
T (mm)	46