

Pneumatic mini slides - Series MSN

Product code: MSN10-15

Datasheet creation date: 10/03/2025 02:28

Check the most updated document online [click here](#)



TECHNICAL DATA

Series	MSN
Bore size (mm)	10

Pneumatic mini slides - Series MSN

Product code: MSN10-15

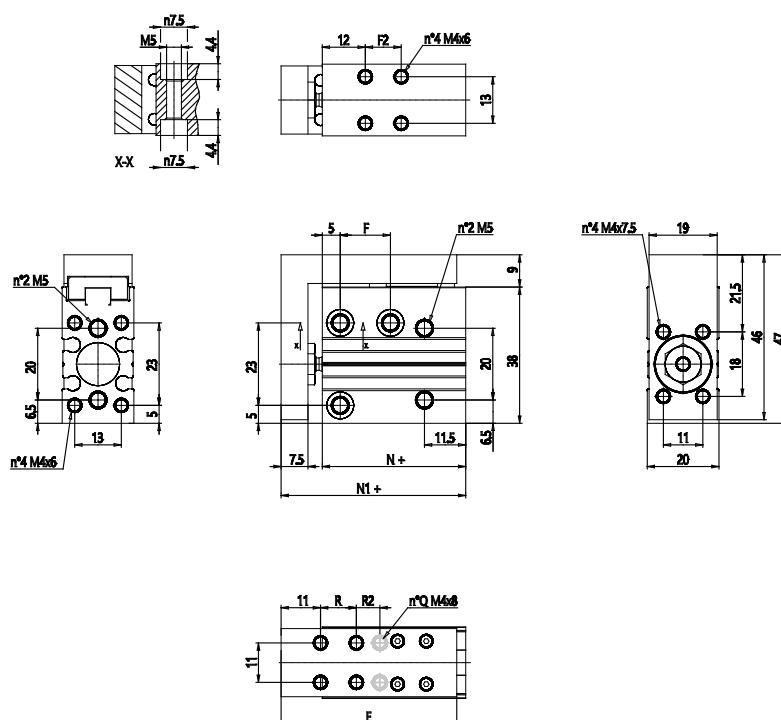

DIMENSIONS

F2 (mm)	20
F (mm)	24.000
R (mm)	20.000
R2 (mm)	-
E (mm)	59.000
N+ (mm)	50.0
N1+ (mm)	61.5
Q (mm)	4.000