

Pneumatic mini slides - Series MSN

Product code: MSN10-30

Datasheet creation date: 10/03/2025 02:29

Check the most updated document online [click here](#)



TECHNICAL DATA

Series	MSN
Bore size (mm)	10

Pneumatic mini slides - Series MSN

Product code: MSN10-30

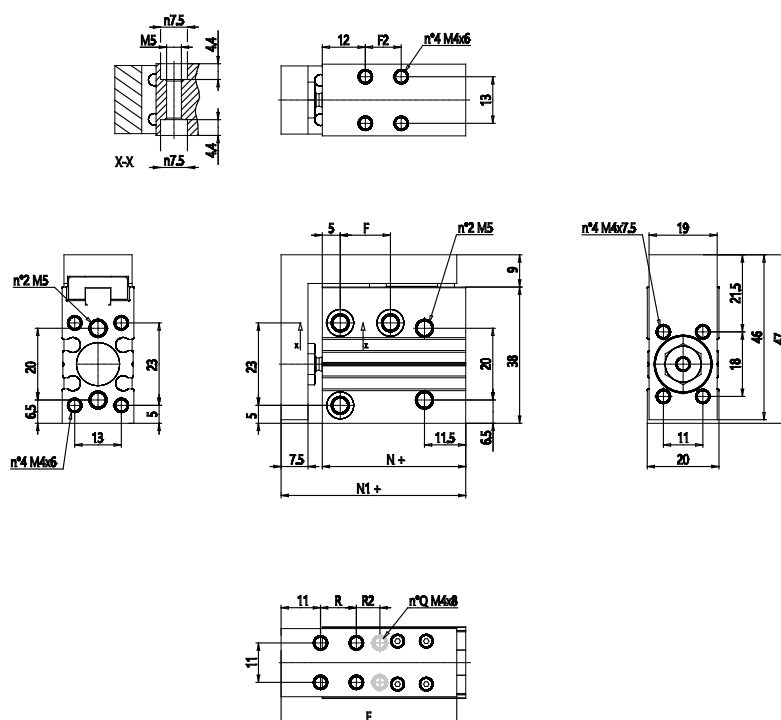

DIMENSIONS

F2 (mm)	35
F (mm)	30.000
R (mm)	30.000
R2 (mm)	-
E (mm)	69.000
N+ (mm)	65.0
N1+ (mm)	76.5
Q (mm)	4.000