

Pneumatic mini slides - Series MSN

Product code: MSN10-40

Datasheet creation date: 10/03/2025 02:29

Check the most updated document online [click here](#)



TECHNICAL DATA

Series	MSN
Bore size (mm)	10

Pneumatic mini slides - Series MSN

Product code: MSN10-40

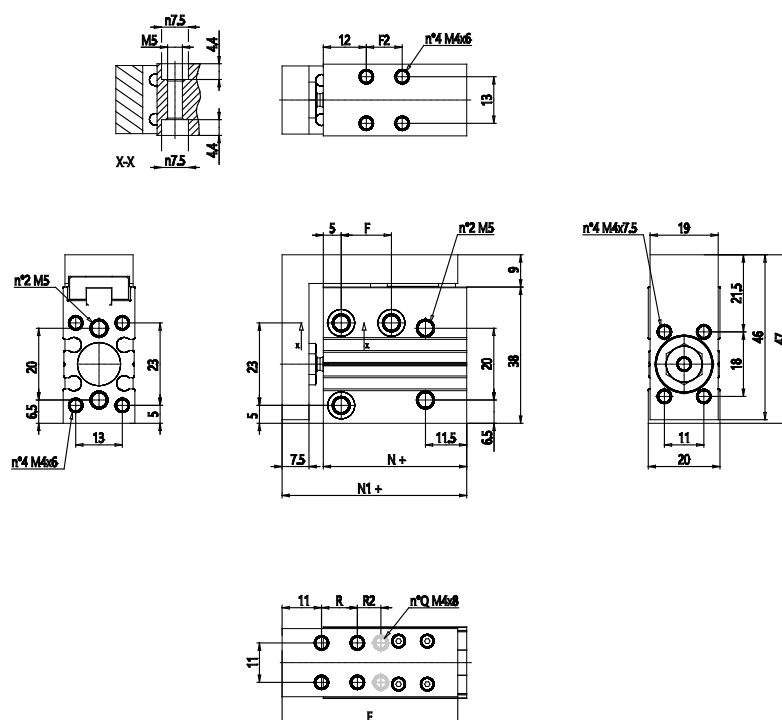

DIMENSIONS

F2 (mm)	45
F (mm)	45.000
R (mm)	20.000
R2 (mm)	20
E (mm)	79.000
N+ (mm)	75.0
N1+ (mm)	86.5
Q (mm)	6.000