

## Pneumatic mini slides - Series MSN

Product code: MSN16-15

Datasheet creation date: 10/03/2025 02:29

Check the most updated document online [click here](#)



### TECHNICAL DATA

Series	MSN
Bore size (mm)	16

## Pneumatic mini slides - Series MSN

Product code: MSN16-15

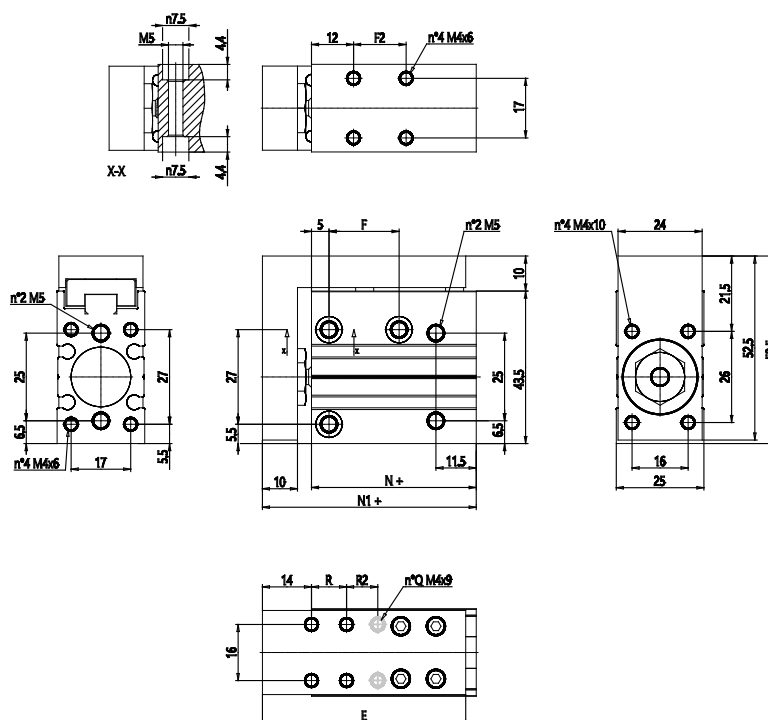

### DIMENSIONS

F2 (mm)	25
F (mm)	30.000
R (mm)	20.000
R2 (mm)	-
E (mm)	68.000
N+ (mm)	57.0
N1+ (mm)	71.0
Q (mm)	4.000