

Pneumatic mini slides - Series MSN

Product code: MSN16-20

Datasheet creation date: 10/03/2025 02:29

Check the most updated document online [click here](#)

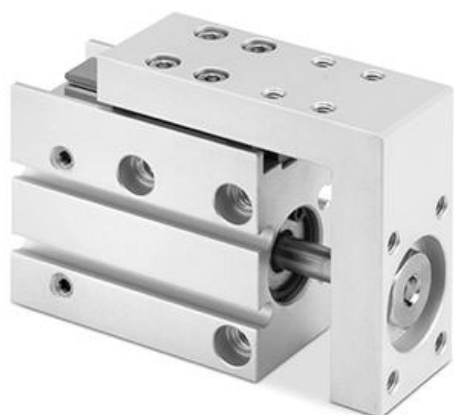

TECHNICAL DATA

Series	MSN
Bore size (mm)	16

Pneumatic mini slides - Series MSN

Product code: MSN16-20

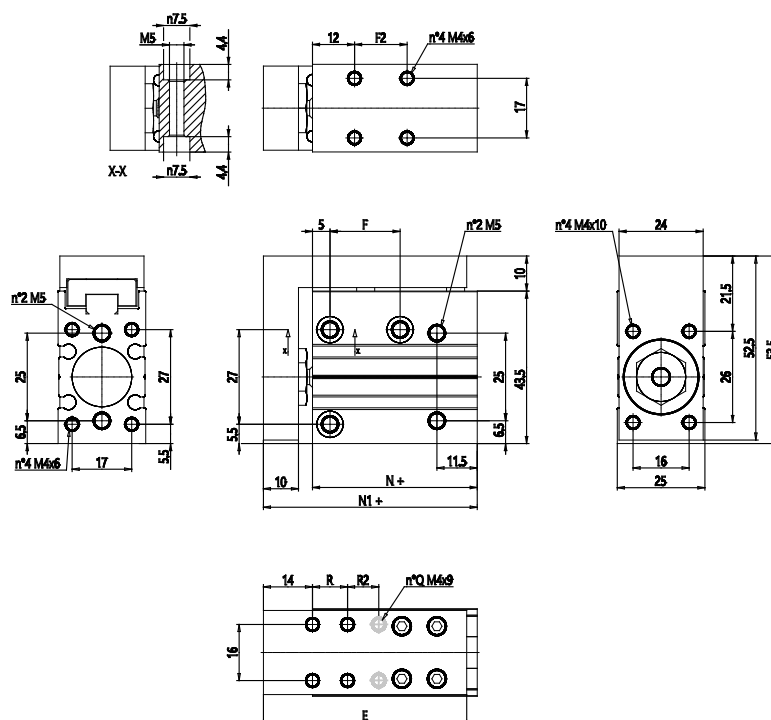

DIMENSIONS

F2 (mm)	30
F (mm)	30.000
R (mm)	20.000
R2 (mm)	-
E (mm)	68.000
N+ (mm)	62.0
N1+ (mm)	76.0
Q (mm)	4.000