

Pneumatic mini slides - Series MSN

Product code: MSN16-5

Datasheet creation date: 10/03/2025 02:29

Check the most updated document online [click here](#)

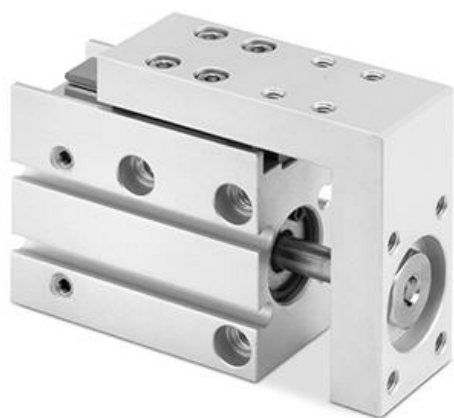

TECHNICAL DATA

Series	MSN
Bore size (mm)	16

Pneumatic mini slides - Series MSN

Product code: MSN16-5

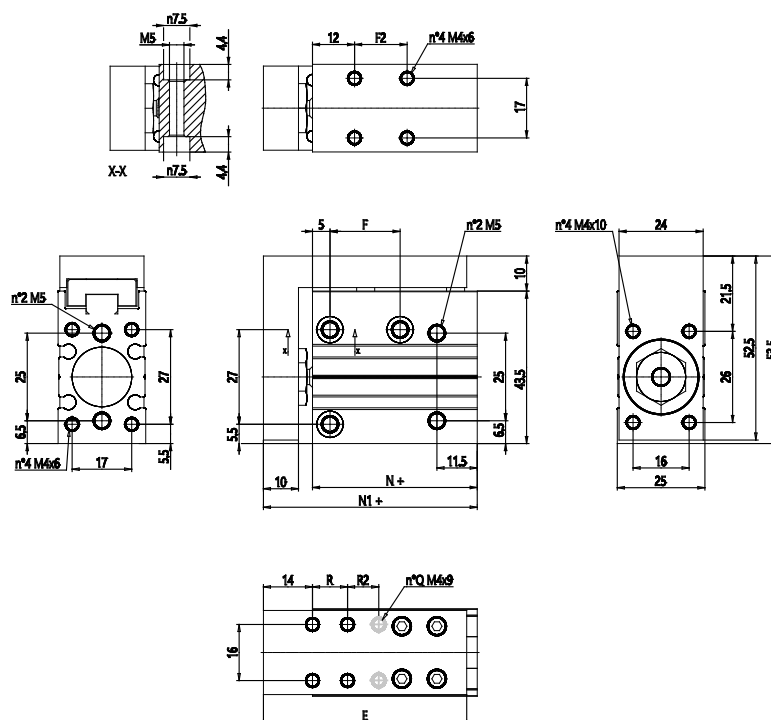

DIMENSIONS

F2 (mm)	15
F (mm)	20.000
R (mm)	10.000
R2 (mm)	-
E (mm)	58.000
N+ (mm)	47.0
N1+ (mm)	61.0
Q (mm)	4.000