

Pneumatic mini slides - Series MSN

Product code: MSN16-50

Datasheet creation date: 10/03/2025 02:29

Check the most updated document online [click here](#)



TECHNICAL DATA

Series	MSN
Bore size (mm)	16

Pneumatic mini slides - Series MSN

Product code: MSN16-50

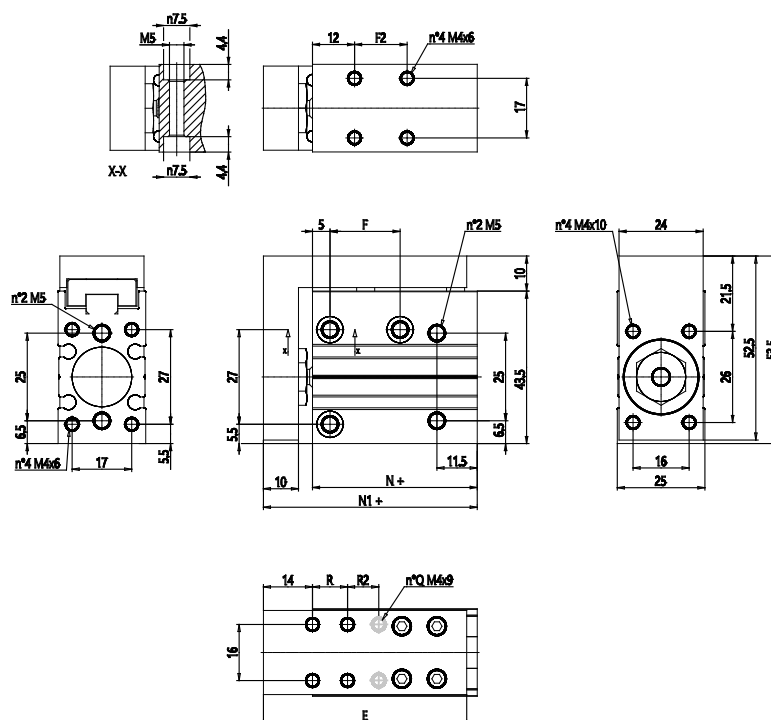

DIMENSIONS

F2 (mm)	60
F (mm)	60.000
R (mm)	25.000
R2 (mm)	25
E (mm)	98.000
N+ (mm)	92.0
N1+ (mm)	106.0
Q (mm)	6.000