

Pneumatic mini slides - Series MSN

Product code: MSN20-30

Datasheet creation date: 10/03/2025 02:29

Check the most updated document online [click here](#)

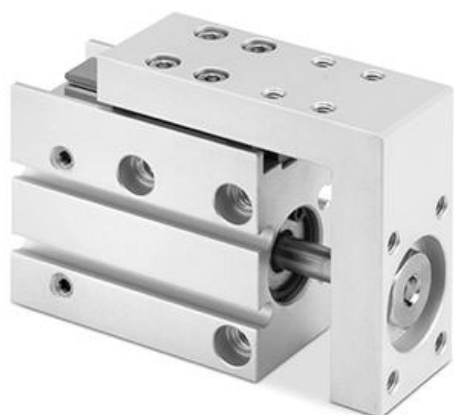

TECHNICAL DATA

Series	MSN
Bore size (mm)	20

Pneumatic mini slides - Series MSN

Product code: MSN20-30

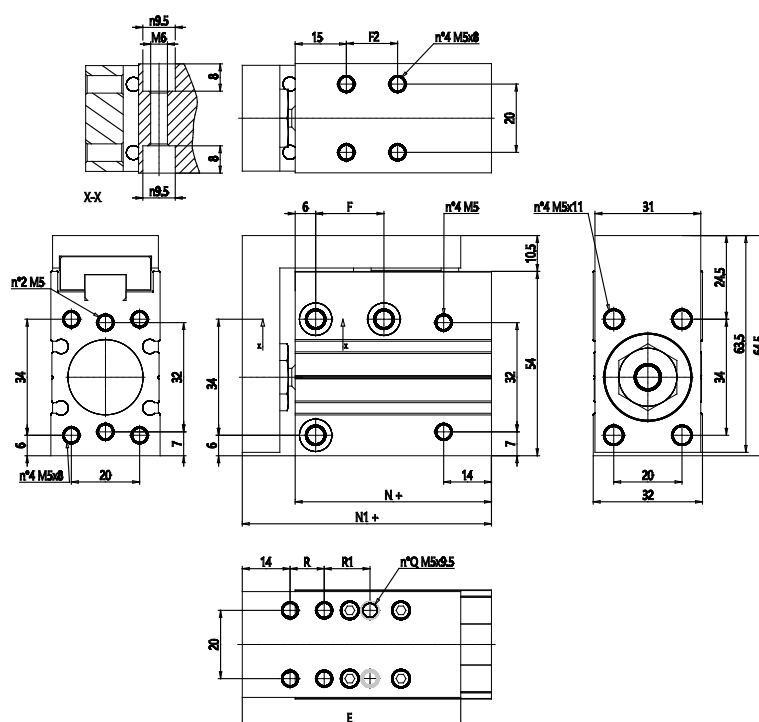

DIMENSIONS

F2 (mm)	40
F (mm)	40.000
R (mm)	30.000
R2 (mm)	-
E (mm)	84.000
N+ (mm)	82.5
N1+ (mm)	98.0
Q (mm)	4.000