

## Pneumatic mini slides - Series MSN

Product code: MSN20-5

Datasheet creation date: 10/03/2025 02:30

Check the most updated document online [click here](#)



### TECHNICAL DATA

Series	MSN
Bore size (mm)	20

## Pneumatic mini slides - Series MSN

Product code: MSN20-5

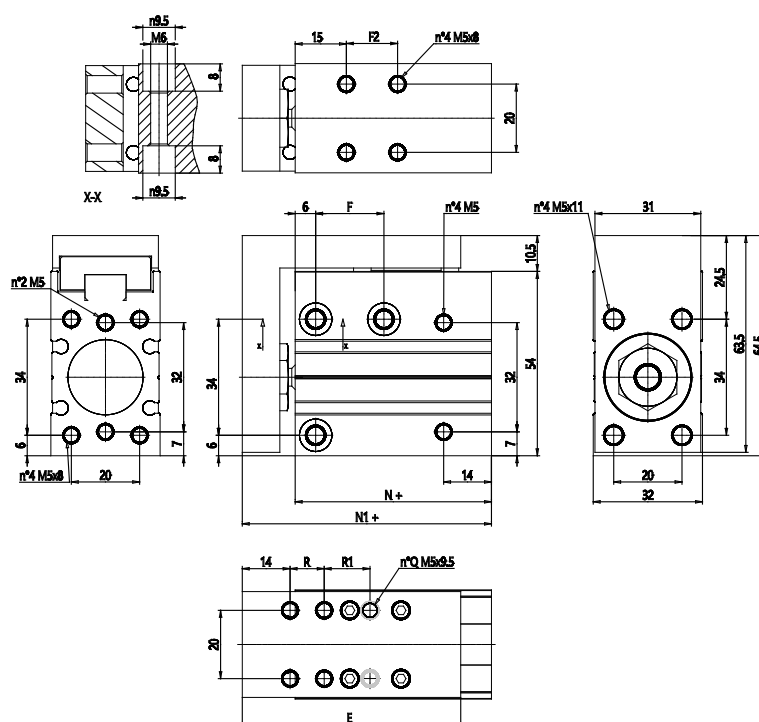

### DIMENSIONS

<b>F2 (mm)</b>	15
<b>F (mm)</b>	20.000
<b>R (mm)</b>	10.000
<b>R2 (mm)</b>	-
<b>E (mm)</b>	64.000
<b>N+ (mm)</b>	57.5
<b>N1+ (mm)</b>	73.0
<b>Q (mm)</b>	4.000