

Pneumatic mini slides - Series MSN

Product code: MSN6-30

Datasheet creation date: 10/03/2025 02:30

Check the most updated document online [click here](#)



TECHNICAL DATA

Series	MSN
Bore size (mm)	6

Pneumatic mini slides - Series MSN

Product code: MSN6-30

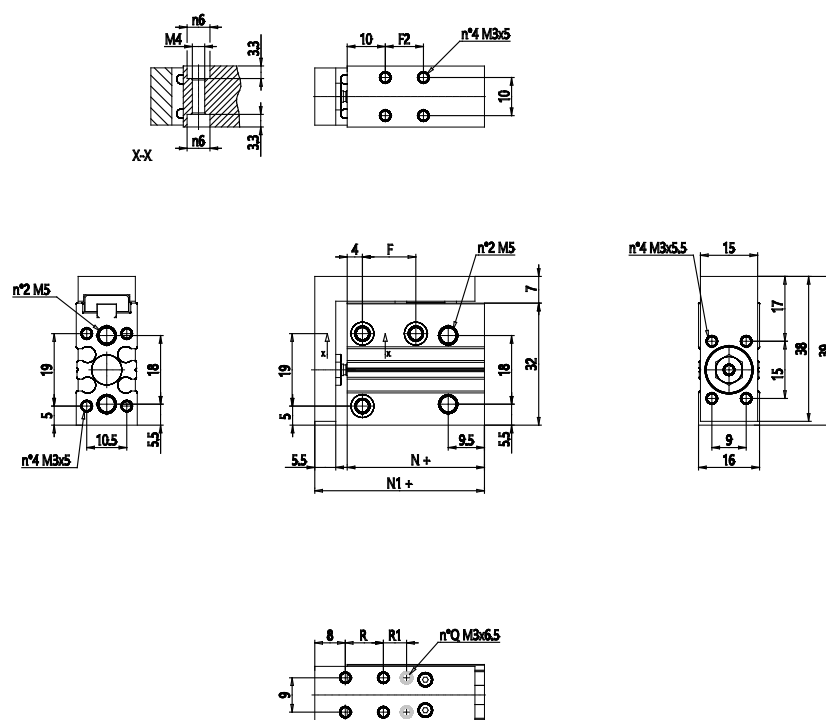

DIMENSIONS

F2 (mm)	35
F (mm)	30.000
R (mm)	30.000
R2 (mm)	-
E (mm)	62.000
N+ (mm)	61.0
N1+ (mm)	69.5
Q (mm)	4.000