

Pneumatic mini slides - Series MSN

Product code: MSN6-5

Datasheet creation date: 10/03/2025 02:30

Check the most updated document online [click here](#)

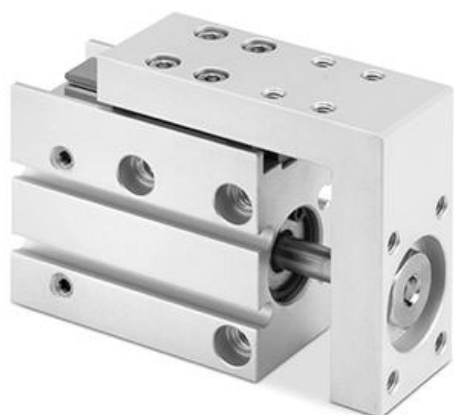

TECHNICAL DATA

Series	MSN
Bore size (mm)	6

Pneumatic mini slides - Series MSN

Product code: MSN6-5

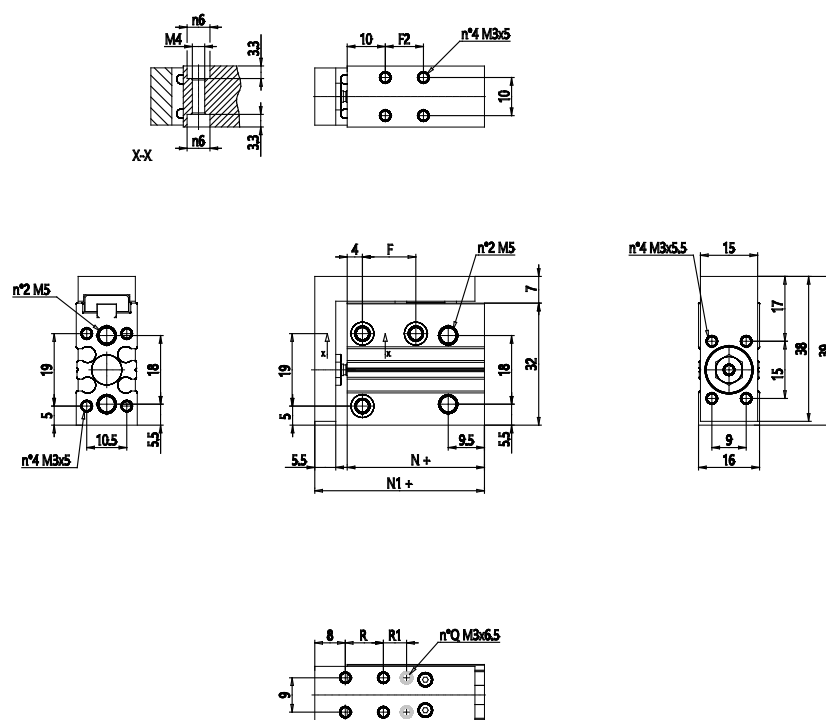

DIMENSIONS

F2 (mm)	10
F (mm)	14.000
R (mm)	10.000
R2 (mm)	-
E (mm)	42.000
N+ (mm)	36.0
N1+ (mm)	44.5
Q (mm)	4.000