

Pneumatic mini slides - Series MST

Product code: MST25-150

Datasheet creation date: 10/03/2025 02:27

Check the most updated document online [click here](#)



TECHNICAL DATA

Series	MST
Bore size (mm)	25

Pneumatic mini slides - Series MST

Product code: MST25-150

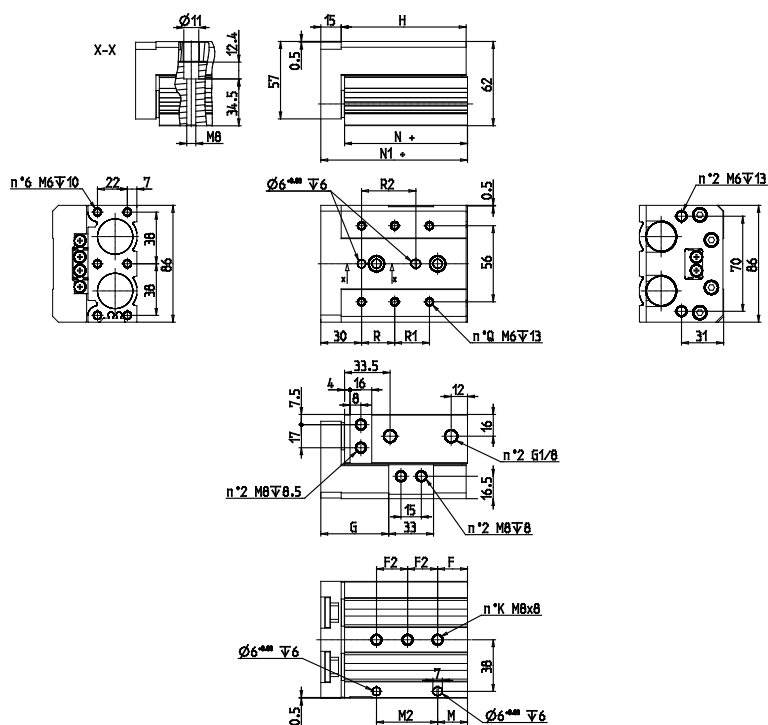

DIMENSIONS

M2 (mm)	80.0
M (mm)	190
F (mm)	30
F2 (mm)	40
R (mm)	80
R2 (mm)	80
G (mm)	190.0
H (mm)	295
P (mm)	0.0
N+ (mm)	293.5
N1+ (mm)	311
N (mm)	8
K (mm)	7
Q (mm)	8