

Pneumatic mini slides - Series MST

Product code: MST25-30

Datasheet creation date: 10/03/2025 02:28

Check the most updated document online [click here](#)



TECHNICAL DATA

Series	MST
Bore size (mm)	25

Pneumatic mini slides - Series MST

Product code: MST25-30

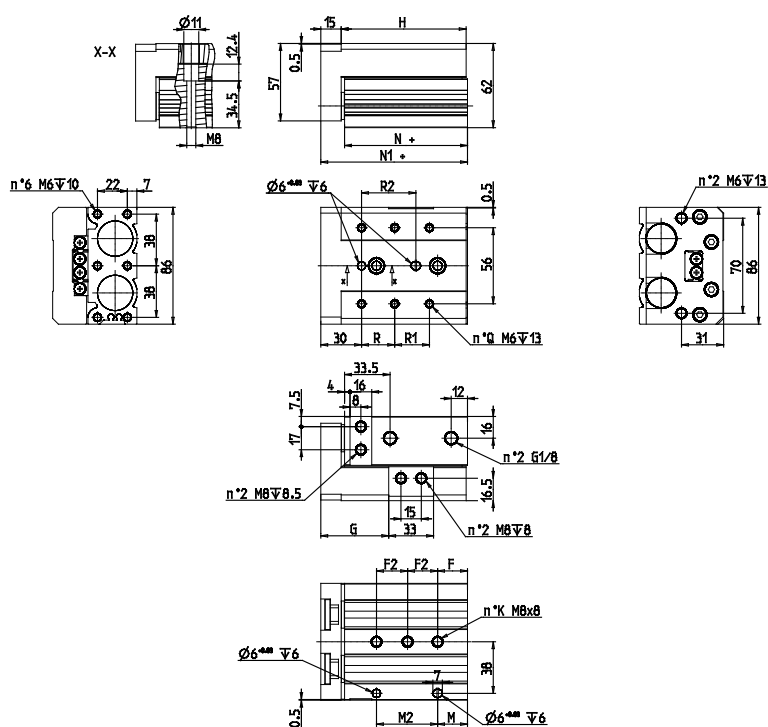

DIMENSIONS

M2 (mm)	45.0
M (mm)	22
F (mm)	22
F2 (mm)	45
R (mm)	50
R2 (mm)	40
G (mm)	70.0
H (mm)	92
P (mm)	0.0
N+ (mm)	90.5
N1+ (mm)	108
N (mm)	4
K (mm)	2
Q (mm)	4