

## Pneumatic mini slides - Series MST

Product code: MST25-40

Datasheet creation date: 10/03/2025 02:28

Check the most updated document online [click here](#)



### TECHNICAL DATA

Series	MST
Bore size (mm)	25

## Pneumatic mini slides - Series MST

Product code: MST25-40

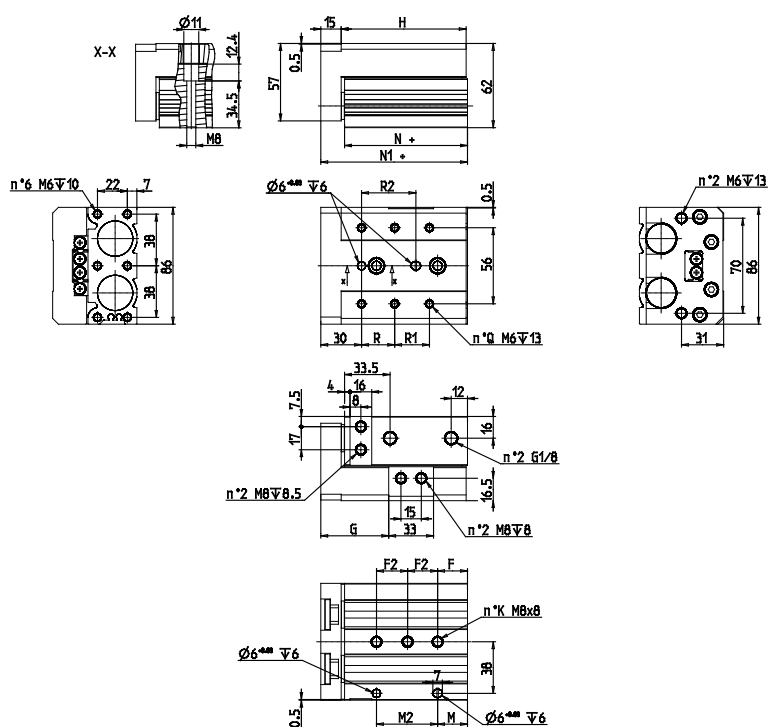

### DIMENSIONS

M2 (mm)	55.0
M (mm)	22
F (mm)	22
F2 (mm)	55
R (mm)	60
R2 (mm)	50
G (mm)	80.0
H (mm)	102
P (mm)	0.0
N+ (mm)	100.5
N1+ (mm)	118
N (mm)	4
K (mm)	2
Q (mm)	4