

## Pneumatic mini slides - Series MST

Product code: MST25-50

Datasheet creation date: 10/03/2025 02:28

Check the most updated document online [click here](#)



### TECHNICAL DATA

Series	MST
Bore size (mm)	25

## Pneumatic mini slides - Series MST

Product code: MST25-50

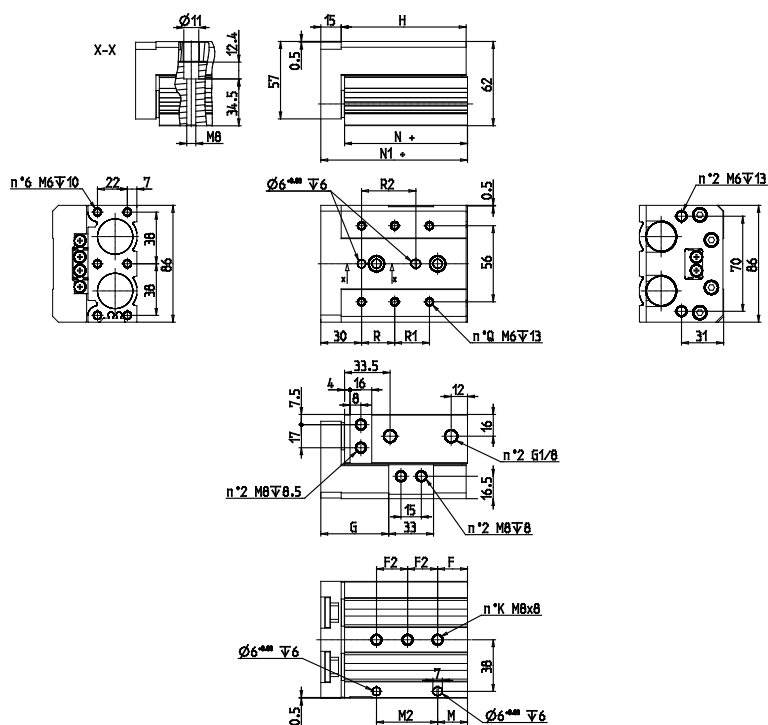

### DIMENSIONS

M2 (mm)	35.0
M (mm)	55
F (mm)	20
F2 (mm)	35
R (mm)	35
R2 (mm)	35
G (mm)	90.0
H (mm)	115
P (mm)	0.0
N+ (mm)	113.5
N1+ (mm)	131
N (mm)	6
K (mm)	3
Q (mm)	6