

## Rapid clamps kit + flanges - Series MX

Product code: MX2-1/2-KK

Datasheet creation date: 19/05/2026 09:09

Check the most updated document online [click here](#)



### TECHNICAL DATA

(mm)	MX
(mm)	2
	KK
(mm)	= BSP thread
	1/2= G 1/2

## Rapid clamps kit + flanges - Series MX

Product code: MX2-1/2-KK

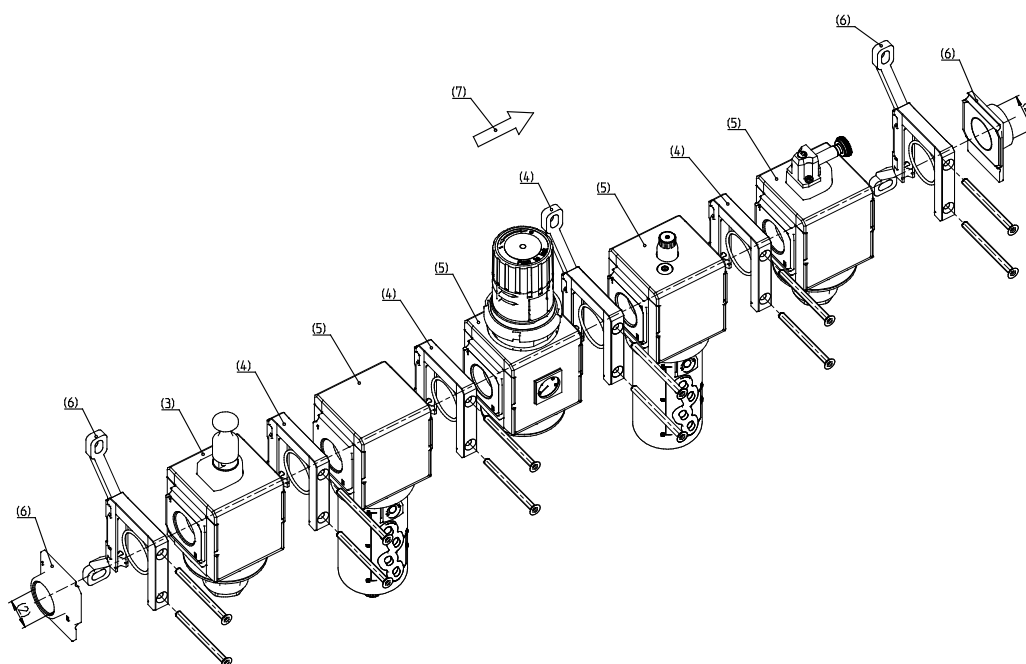

	(1)	(2)	(3)	(4)	(5)	(6)	(7)
MX	3	-				-	

### DIMENSIONS

(mm)	MX
(mm)	2
	KK
(mm)	= BSP thread
	1/2= G 1/2