

Proportional pressure regulator and proportional flow valve - Series MX-PRO

Product code: MX2-1/2-MEV110

Datasheet creation date: 10/03/2025 00:41

Check the most updated document online [click here](#)



TECHNICAL DATA

Series	MX
Size	2
Port	1/2=G1/2
Functioning	M = Manifold pressure regulator
Command	EV = electrical command 0-10 V DC with external servo pilot supply
Regulator adjustment range	1 = working pressure 0 ± 3 bar
Design type	1= without relieving
Pressure gauge	0 = without manometer, threaded body
Flow direction	= from left to right (standard)

Proportional pressure regulator and proportional flow valve - Series MX-PRO

Product code: MX2-1/2-MEV110

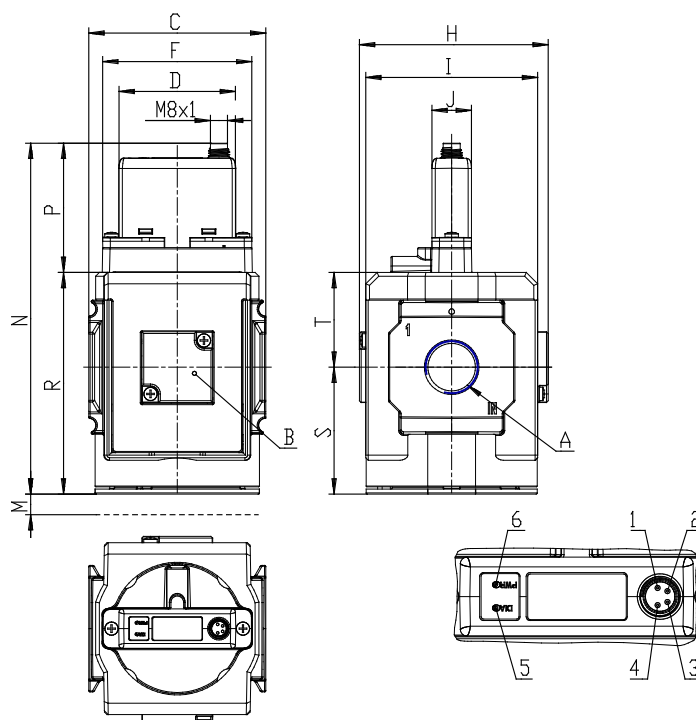

DIMENSIONS

Series	MX
Size	2
Port	1/2=G1/2
Functioning	M = Manifold pressure regulator
Command	EV = electrical command 0-10 V DC with external servo pilot supply
Regulator adjustment range	1 = working pressure 0 ± 3 bar
Design type	1= without relieving
Pressure gauge	0 = without manometer, threaded body
Flow direction	= from left to right (standard)