

## Proportional pressure regulator and proportional flow valve - Series MX-PRO

Product code: MX2-1/2-RCA200

Datasheet creation date: 10/03/2025 00:41

Check the most updated document online [click here](#)



### TECHNICAL DATA

<b>Series</b>	MX
<b>Size</b>	2
<b>Port</b>	1/2=G1/2
<b>Functioning</b>	R = pressure regulator
<b>Command</b>	CA = electrical command 4-20 mA
<b>Regulator adjustment range</b>	2 = working pressure $0 \pm 10$ bar
<b>Design type</b>	0 = relieving
<b>Pressure gauge</b>	0 = without manometer, threaded body
<b>Flow direction</b>	= from left to right (standard)

## Proportional pressure regulator and proportional flow valve - Series MX-PRO

Product code: MX2-1/2-RCA200

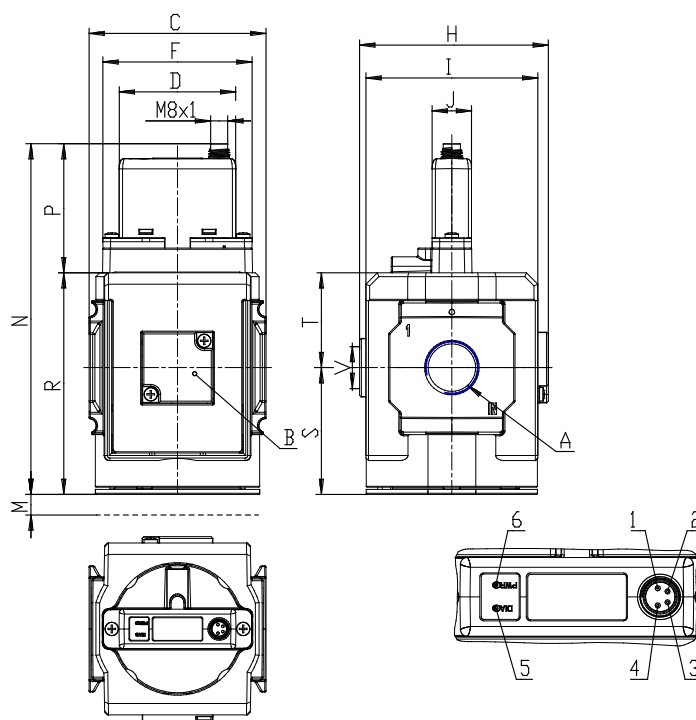

### DIMENSIONS

<b>Series</b>	MX
<b>Size</b>	2
<b>Port</b>	1/2=G1/2
<b>Functioning</b>	R = pressure regulator
<b>Command</b>	CA = electrical command 4-20 mA
<b>Regulator adjustment range</b>	2 = working pressure $0 \pm 10$ bar
<b>Design type</b>	0 = relieving
<b>Pressure gauge</b>	0 = without manometer, threaded body
<b>Flow direction</b>	= from left to right (standard)